

Zehnder ZFP

Planning document for Zehnder Flexible Panels for heating and cooling



Delivering comfort, energy-saving operation and flexibility

Zehnder ZFP radiant ceiling panels heat and cool a building comfortably and efficiently. They can be used in all rooms from approximately 2 m to 50 m in height, and compared to other systems, they can achieve energy savings of up to 40%.

Zehnder ZFP radiant ceiling panels are available in a variety of designs. The individual elements of the Zehnder ZFP are designed as an innovative modular system and can be combined with each other according to the project requirements to create tailored solutions.

Each project is produced to customers' specific order requirements and supplied in line with the on-site workflow. Get in touch to find out more.



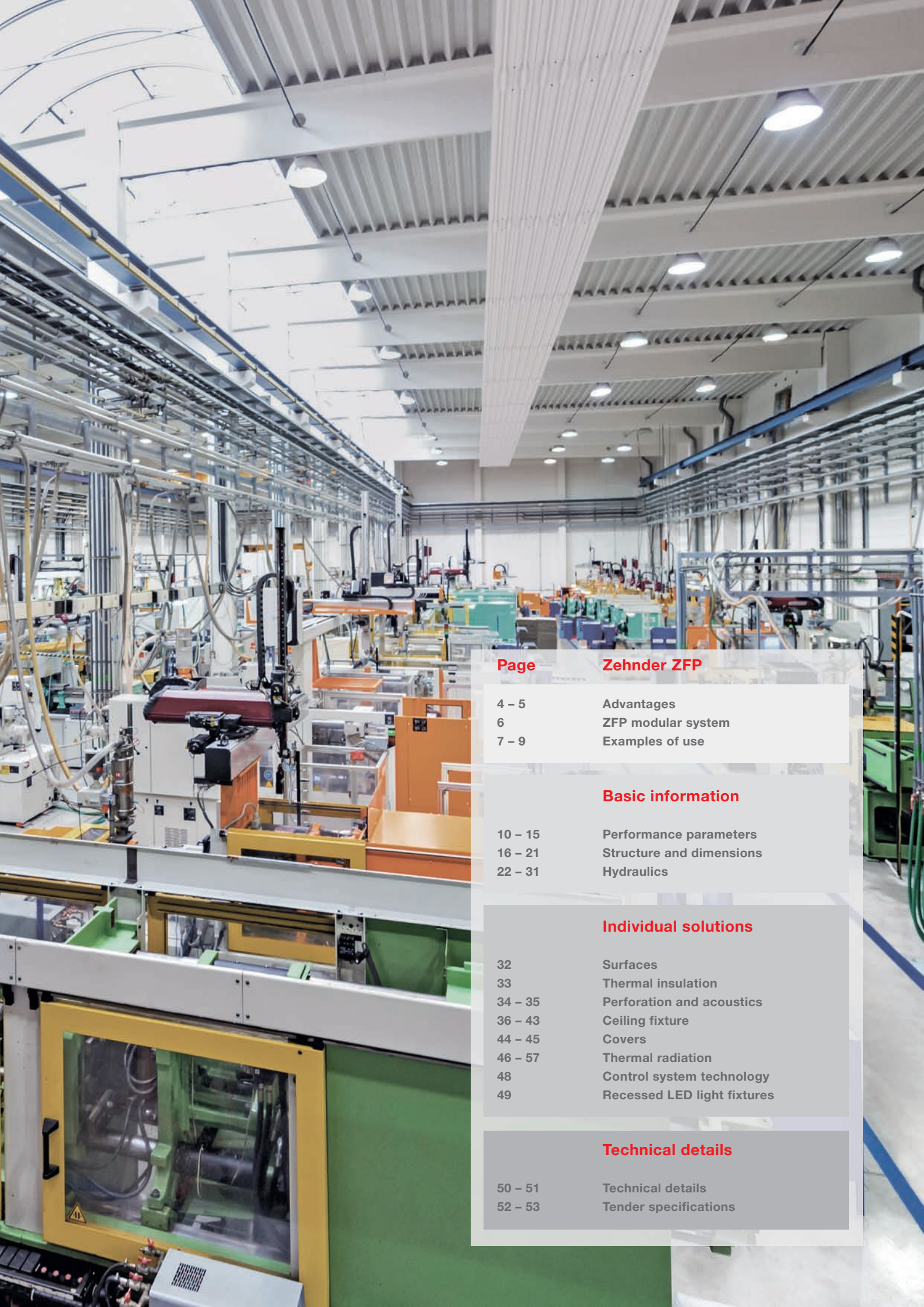

Page **Zehnder ZFP**

4 – 5	Advantages
6	ZFP modular system
7 – 9	Examples of use

Basic information

10 – 15	Performance parameters
16 – 21	Structure and dimensions
22 – 31	Hydraulics

Individual solutions

32	Surfaces
33	Thermal insulation
34 – 35	Perforation and acoustics
36 – 43	Ceiling fixture
44 – 45	Covers
46 – 57	Thermal radiation
48	Control system technology
49	Recessed LED light fixtures

Technical details

50 – 51	Technical details
52 – 53	Tender specifications

Zehnder ZFP – flexibility and efficiency

Bespoke solutions

The flexible modular system offers the perfect heating and cooling solution for every room.

Maximum corrosion resistance

The systematic full galvanisation of all components guarantees a long service life – a sensible economic investment for the future.

Optimal indoor climate all year round

Not only does Zehnder ZFP provide comfortable warmth in the winter, it also ensures pleasant temperatures in the summer with draught-free cooling.

Minimal installation work

The modules' impressive stability means that fewer suspension points are required, significantly reducing installation time.

Low investment costs

Optimum overall performance with optimum thermal radiation. This results in lower investment costs, as fewer ceiling panels need to be installed to cover the heat load.

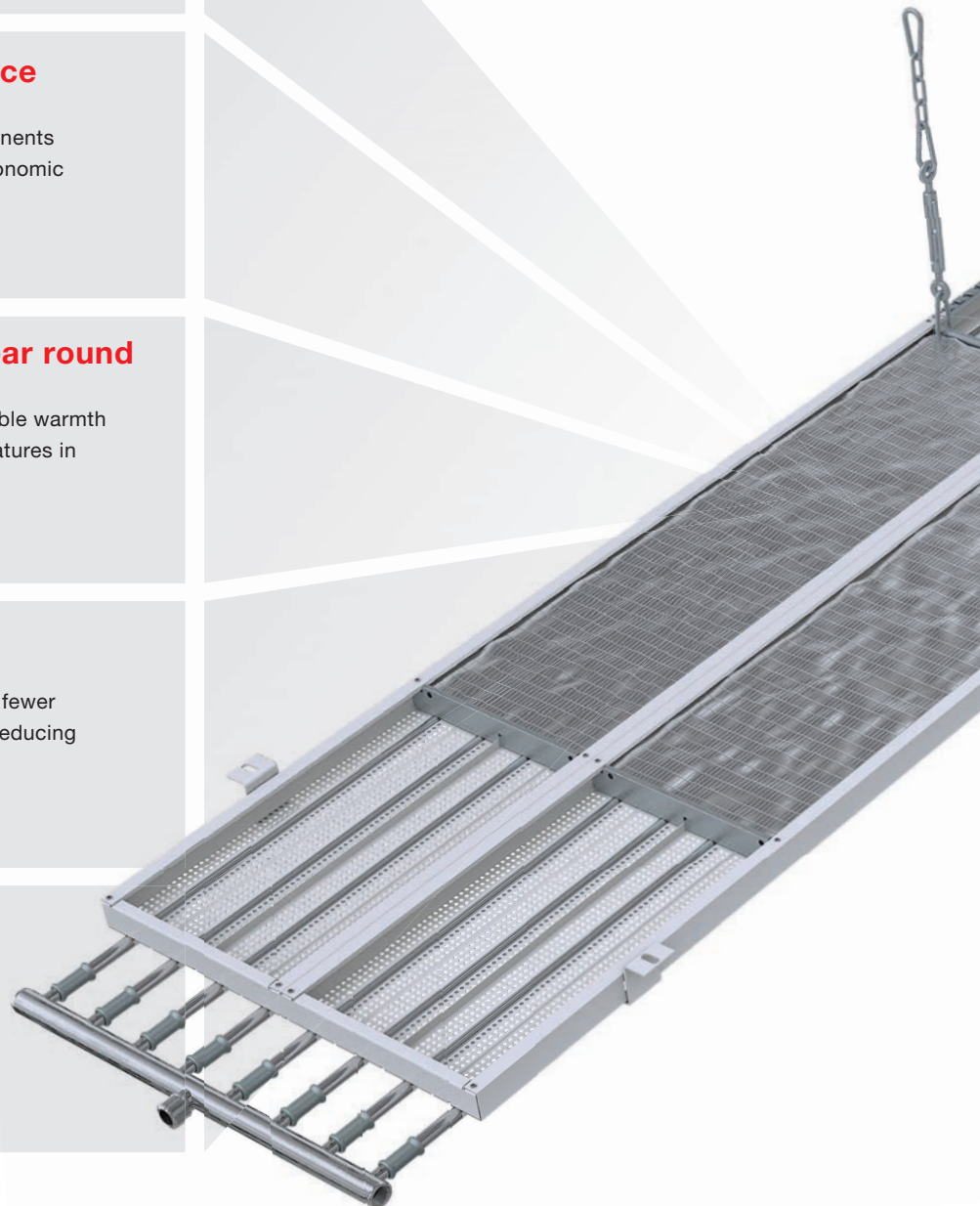



Easy and quick to retrofit

The thermal radiation shield and optional insulation concept can be retrofitted to increase Zehnder ZFP's thermal radiation to up to 89%. Coordinated components from the modular system mean that these elements can easily be retrofitted at any time.

Wide range of applications

Zehnder ZFP weighs only around 14 kg/m², so it is even suitable for low roof loads.

Refined design

A tube diameter of only 15 mm gives Zehnder ZFP a harmonious design that blends into any architectural context.

Efficient heating and cooling

Zehnder ZFP can achieve a proportion of radiation up to 89%, allowing the energy supplied to be efficiently transmitted.

Forward-looking technology

Zehnder ZFP can be operated with a wide range of system temperatures. This means it can be combined with modern heat pumps, which have lower flow temperatures, without any issues.

Heating and cooling according to the modular principle: Zehnder ZFP

The wide range of projects we see today requires customised heating and cooling solutions. The dimensions of the space and the way the building is used are the primary factors when it comes to designing the system layout and selecting from the various installation options. With ZFP, Zehnder has developed a modular system that offers maximum flexibility. The individual product components can be combined in different ways according to the specific project requirements. Why not explore the wide range of options we can offer? We will be happy to support your planning efforts.

Zehnder ZFP modular design

Basic information	Performance parameters <ul style="list-style-type: none"> ● ▲ ■ Heating and cooling performance ● ▲ ■ Temperature limit ● ▲ ■ Minimum mass flow Inclination 	Structure and dimensions <ul style="list-style-type: none"> ● ▲ ■ Dimensions ● ▲ ■ Connector technology 	Hydraulics <ul style="list-style-type: none"> ● ▲ ■ Headers / collectors ● ▲ ■ Pressure loss calculation ● ▲ ■ Hydraulic balancing Volume flow controller
	Surface <ul style="list-style-type: none"> ▲ Smooth ● ■ Perforation ▲ Standard colour ● ■ Special colour 	Thermal insulation <ul style="list-style-type: none"> ▲ Aluminium-laminated mineral wool ■ Mineral wool in foil ● Acoustic insulation ● ■ Sound absorption 	Ceiling fixture <ul style="list-style-type: none"> Wooden ceiling Concrete ceiling Steel profile Trapezoidal sheet metal Steel girders (angled/horizontal) Reinforcement axes / Variable axes Support tracks Z-profiles
	Covers <ul style="list-style-type: none"> ● ▲ ■ Cover plate ● Ball guards Dust protector panel ● ■ End cover header ● ■ Raised headers 	Special requirements <ul style="list-style-type: none"> Non-continuous radiant panel plate Cut-outs for fixtures Thermal radiation shield 	Additional components <ul style="list-style-type: none"> Control system technology ▲ ■ LED 2.0 lighting
Individual solutions			

- Example: Modular system for a sports hall
- ▲ Example: Modular system for a warehouse
- Example: Modular system for a showroom

● Example: Sports hall

⊕ Perforation and acoustic insulation

- Optimised properties for room acoustics
- Low reverberation
- Attractive look

⊕ Ball guards

- Sports activities are not affected by loss of balls
- Ball impact resistance to DIN 18032

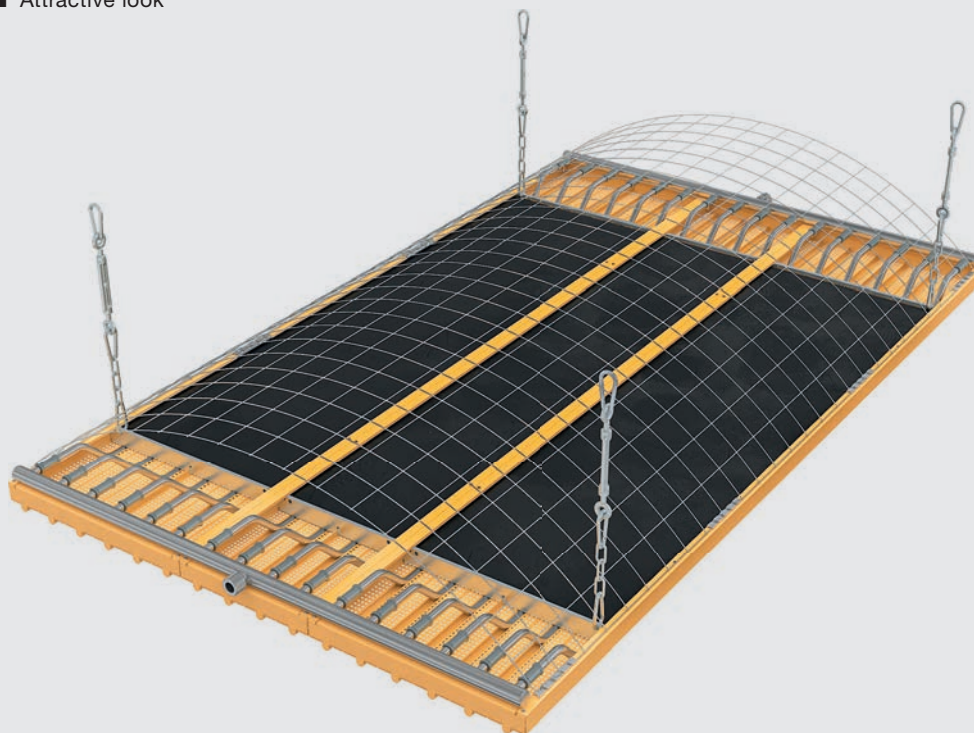

⊕ Raised headers

- Connections not visible
- Integrated ceiling solution possible
- Uniform appearance

⊕ Special colour

- Available in over 700 colours



▲ Example: Warehouse

⊕ **Model width**

- Narrow design – ideal for high-bay warehouses
- Radiant heat used according to requirements
- Can be used in combination with sprinkler systems

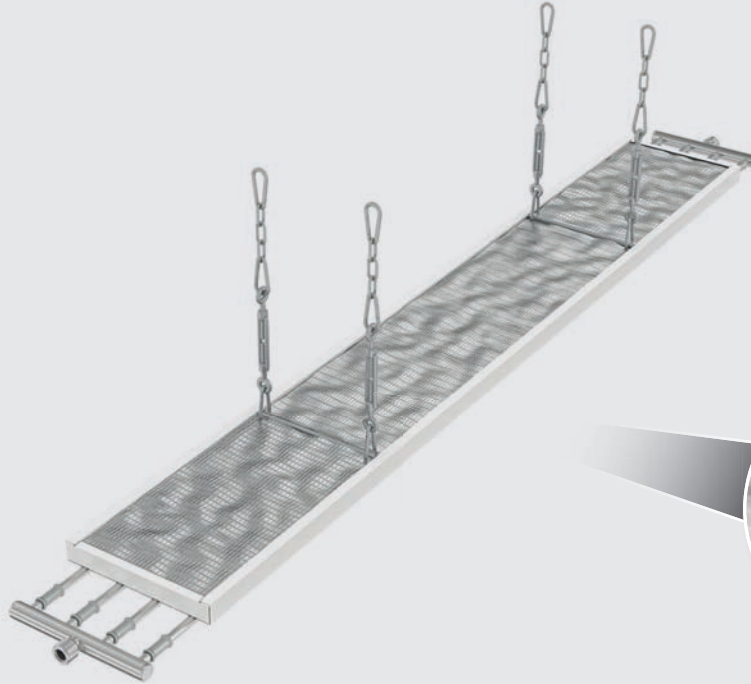

Detailed view from below

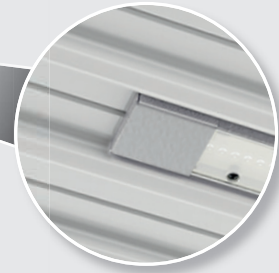

⊕ **LED lights**

- Perfect lighting for the showroom
- Individual lighting calculations
- Lighting integrated into modules



■ Example: Showroom

⊕ Perforation and acoustic insulation

- Optimised properties for room acoustics
- Low reverberation
- Attractive look

⊕ Raised headers

- Connections not visible
- Integrated ceiling solution possible

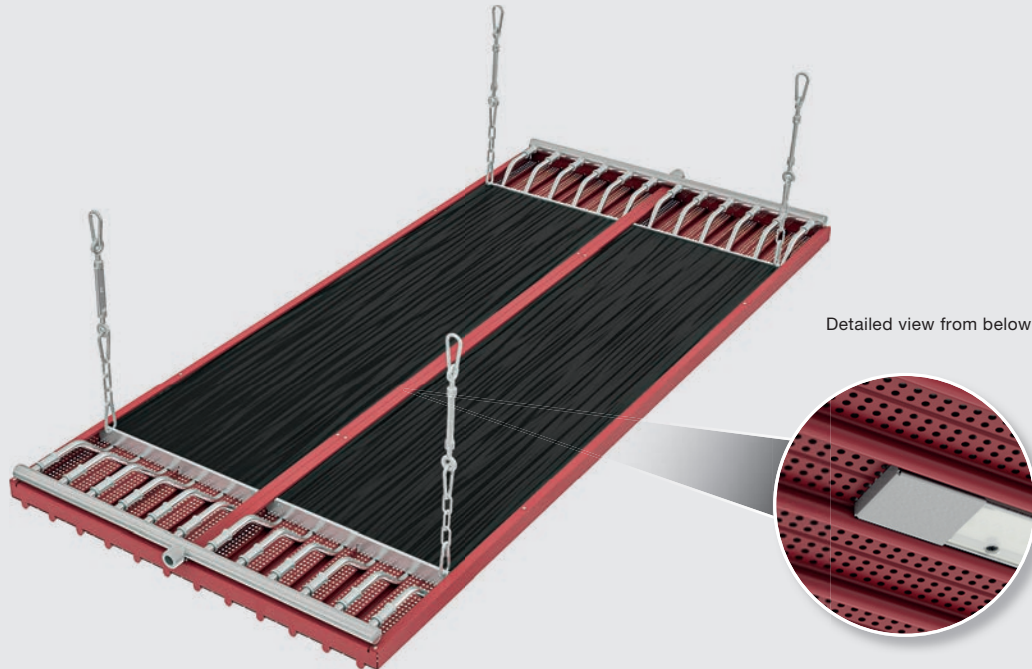

⊕ Special colour

- Available in over 700 colours

⊕ LED lights

- Perfect lighting for the showroom
- Individual lighting calculations
- Harmonious look as lighting is integrated into the radiant panel system



Heating and cooling performance

The following tables show the heating and cooling performance of the Zehnder ZFP radiant ceiling panels depending on the heating Delta T and the cooling Delta T. The thermal output values have been stated according to DIN EN 14037-3, while the measurement results for the cooling capacity with insulation are based on DIN EN 14037-4. The values of the cooling performance without insulation are stated based on DIN EN 14037-4.

Note: removing the insulation has a positive effect on the cooling capacity. Removing the insulation increases the thermal output, but can lead to heat accumulation under the ceiling.

Zehnder ZFP radiant ceiling panels can be used for cooling at any time, as all components are supplied in galvanised or completely galvanised versions.

$$\text{Output } \dot{Q} = K \cdot \Delta T^n$$

The heating Delta T and cooling Delta T can be calculated arithmetically:

$$t_i = t_E = \frac{(t_U + t_L)}{2}$$

$$\Delta T_{\text{heating}} = \frac{(t_{hf} + t_{hr})}{2} - t_i$$

$$\Delta T_{\text{cooling}} = t_i - \frac{(t_{cf} + t_{cr})}{2}$$

Cooling capacity with insulation									
	300/4	450/6	600/8	750/10	900/12	1050/14	1200/16	1350/18	1500/20
K	2.752	4	5.247	6.383	7.518	8.653	9.789	11.006	12.224
n	1.1	1.1	1.1	1.1	1.1	1.1	1.1	1.1	1.1
ΔT_{cool} (K)	W/m	W/m	W/m	W/m	W/m	W/m	W/m	W/m	W/m
15	54	79	103	126	148	170	193	216	240
14	50	73	96	116	137	158	178	201	223
13	46	67	88	107	126	145	164	185	205
12	42	62	81	98	116	133	151	169	188
11	38	56	73	89	105	121	137	154	171
10	35	50	66	80	95	109	123	139	154
9	31	45	59	72	84	97	110	123	137
8.5	29	42	55	67	79	91	103	116	129
8	27	39	52	63	74	85	96	108	120
7	23	34	45	54	64	74	83	94	104
6	20	29	38	46	54	62	70	79	88
5	16	23	31	37	44	51	57	65	72

Cooling capacity without insulation									
	300/4	450/6	600/8	750/10	900/12	1050/14	1200/16	1350/18	1500/20
K	3.302	4.800	6.296	7.660	9.022	10.384	11.747	13.207	14.669
n	1.1	1.1	1.1	1.1	1.1	1.1	1.1	1.1	1.1
ΔT_{cool} (K)	W/m	W/m	W/m	W/m	W/m	W/m	W/m	W/m	W/m
15	65	94	124	151	177	204	231	260	288
14	60	87	115	140	164	189	214	241	267
13	55	81	106	129	152	174	197	222	246
12	51	74	97	118	139	160	181	203	226
11	46	67	88	107	126	145	164	185	205
10	42	60	79	96	114	131	148	166	185
9	37	54	71	86	101	116	132	148	164
8.5	35	51	66	81	95	109	124	139	154
8	33	47	62	75	89	102	116	130	144
7	28	41	54	65	77	88	100	112	125
6	24	34	45	55	65	75	84	95	105
5	19	28	37	45	53	61	69	78	86

Legend

- t_{air} Air temperature (°C)
- t_{sur} Surrounding surface temperature (°C)
- = average radiant temperature
- = average surface temperature of all surfaces in the surrounding area (°C)
- t_i = t_p Indoor temperature (°C)
- = perceived temperature (°C)
- t_{hf} Heating flow temperature (°C)
- t_{hr} Heating return temperature (°C)
- t_{cf} Cooling flow temperature (°C)
- t_{cr} Cooling return temperature (°C)
- ΔT_{heat} Heating Delta T (K)
- ΔT_{cool} Cooling Delta T (K)
- K Constant
- n Exponent
- Q̇ Output
- Q̇_g Total thermal output
- s Inclination correction factor

Physical units

- Degree centigrade (°C)
- Kelvin (K)
- Cubic metre (m³)
- Metre (m)
- Millimetre (mm)
- Pascal (Pa)
- Kilogram (kg)

Thermal output with insulation

	300/4		450/6		600/8		750/10		900/12		1050/14		1200/16		1350/18		1500/20	
K n	1.695	0.413	2.420	0.613	3.170	0.760	3.839	1.031	4.517	1.334	5.204	1.671	5.899	2.044	6.732	2.087	7.600	2.098
	1.193	1.219	1.188	1.251	1.184	1.282	1.182	1.267	1.181	1.252	1.179	1.237	1.177	1.222	1.172	1.249	1.166	1.277
ΔT_{heat} (K)	W/m	W/MP	W/m	W/MP	W/m	W/MP	W/m	W/MP	W/m	W/MP	W/m	W/MP	W/m	W/MP	W/m	W/MP	W/m	W/MP
90	363	100	508	170	652	243	784	308	916	373	1,048	436	1,179	498	1,311	576	1,443	655
88	354	97	495	166	635	236	764	300	892	362	1,020	424	1,148	485	1,277	560	1,406	637
86	344	94	482	161	618	229	743	291	868	352	993	412	1,118	471	1,243	544	1,369	618
84	335	92	468	156	601	223	723	283	845	342	966	400	1,087	458	1,210	528	1,331	600
82	325	89	455	152	584	216	703	274	821	332	939	389	1,057	445	1,176	513	1,295	582
80	316	86	442	147	567	209	682	266	797	322	912	377	1,026	432	1,142	497	1,258	564
78	306	84	429	142	551	202	662	257	774	312	885	365	996	418	1,109	482	1,221	546
76	297	81	416	138	534	196	642	249	751	302	858	354	966	405	1,076	466	1,185	528
74	288	79	403	133	517	189	622	241	727	292	832	342	936	392	1,043	451	1,149	510
72	278	76	390	129	501	183	603	233	704	282	805	331	907	379	1,010	436	1,112	493
70	269	73	377	124	485	176	583	224	681	272	779	320	877	367	977	421	1,077	475
68	260	71	364	120	468	170	563	216	658	262	753	308	848	354	944	406	1,041	458
66	251	68	352	116	452	163	544	208	635	253	727	297	818	341	912	391	1,005	441
64	242	66	339	111	436	157	524	200	613	243	701	286	789	329	880	376	970	424
62	233	63	326	107	420	151	505	192	590	234	675	275	760	316	847	362	934	407
60	224	61	314	103	404	145	486	185	568	224	649	264	731	304	815	347	899	391
58	215	58	302	98	388	138	467	177	545	215	624	253	703	291	784	333	865	374
56	206	56	289	94	372	132	448	169	523	206	599	242	674	279	752	318	830	358
55	202	55	283	92	364	129	438	165	512	201	586	237	660	273	736	311	813	349
54	198	54	277	90	356	126	429	161	501	197	574	232	646	267	721	304	795	341
52	189	51	265	86	341	120	410	154	479	188	549	221	618	255	690	290	761	325
50	180	49	253	82	325	114	392	146	458	179	524	211	590	243	659	276	727	309
48	172	46	241	78	310	109	373	139	436	170	499	200	562	231	628	263	693	294
46	163	44	229	74	295	103	355	132	415	161	475	190	535	220	597	249	660	278
44	155	42	217	70	280	97	337	125	394	152	451	180	508	208	567	236	626	263
42	146	39	205	66	265	92	319	117	373	144	427	170	481	196	537	222	593	248
40	138	37	194	62	250	86	301	110	352	135	403	160	454	185	507	209	561	233
38	130	35	182	58	235	81	283	103	331	127	379	150	427	174	478	196	528	218
36	122	33	171	54	221	75	266	97	311	118	356	140	401	163	448	183	496	203
34	114	30	160	50	206	70	248	90	290	110	332	131	375	152	419	171	464	189
32	106	28	149	47	192	65	231	83	270	102	310	121	349	141	390	158	432	175
30	98	26	138	43	178	59	214	77	250	94	287	112	323	130	362	146	401	161
28	90	24	127	40	164	54	197	70	231	86	264	103	298	120	334	134	370	148
26	83	22	116	36	150	49	181	64	212	79	242	94	273	109	306	122	339	134
24	75	20	106	33	136	45	164	58	192	71	221	85	249	99	279	110	309	121
22	68	18	95	29	123	40	148	52	174	64	199	76	224	89	252	99	279	109
20	60	16	85	26	110	35	133	46	155	57	178	68	201	79	225	88	250	96
18	53	14	75	23	97	31	117	40	137	50	157	60	177	70	199	77	221	84
16	46	12	65	20	84	27	102	35	119	43	137	52	154	60	173	67	193	72
14	39	10	56	17	72	22	87	29	102	36	117	44	132	51	148	56	165	61
12	33	9	46	14	60	18	72	24	85	30	97	36	110	43	124	46	138	50
10	26	7	37	11	48	15	58	19	68	24	79	29	89	34	100	37	111	40

MP = manifold pair

Temperature limits

The right design temperature must be selected so that the radiant system can maintain a comfortable indoor climate. You can use the following table and graph to check this design temperature, which must be lower than the temperature limit (average heating temperature). Higher temperature limits can be used for rooms and corridors where people do not spend a great deal of time.

Temperature limits						
Height m	Proportion of the ceiling surface covered by Zehnder ZFP radiant ceiling panels					
	10%	15%	20%	25%	30%	35%
Average heating temperature in °C						
≤ 3	73	71	68	64	58	56
4	115	105	91	78	67	60
5	>147	123	100	83	71	64
6		132	104	87	75	69
7		137	108	91	80	74
8		>141	112	96	86	80
9			117	101	92	87
10			122	107	98	94

Step 1: Ceiling coverage. The design temperature must not exceed the defined thresholds.

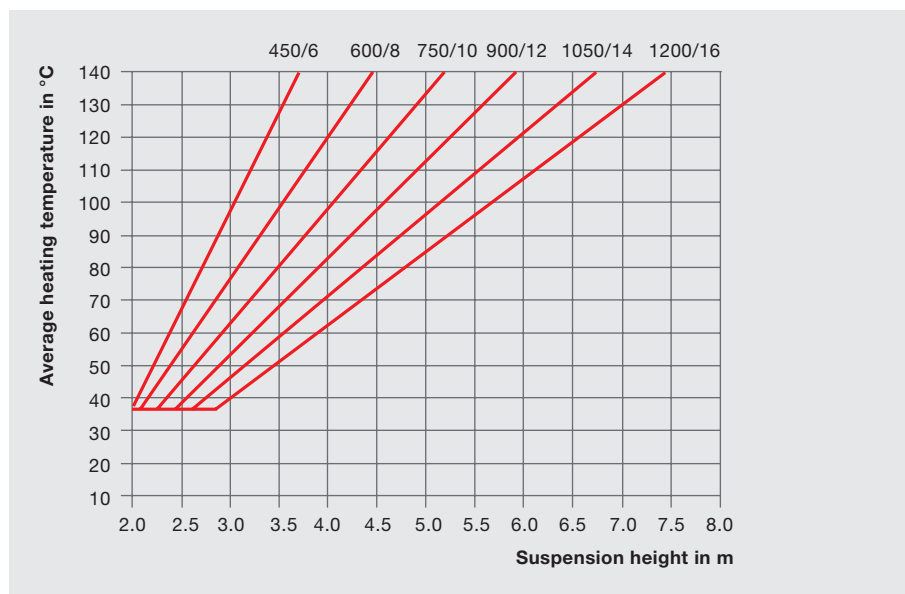

Step 2: Width of the radiant panel. The design temperature must not exceed the defined thresholds.

The specifications are approximate. A detailed calculation can be performed according to ISO 7730.

Minimum mass flow

To maintain the output shown in the table, a turbulent flow must be ensured within the tubes in the modules. The minimum mass flow required for this depends on the lowest system temperature. When heating, this corresponds to the return temperature. When cooling or in a combined cooling/heating mode, this corresponds to the cooling flow temperature. If the minimum mass flow per tube is not achieved, this can result in a drop in performance of around 15%.

Minimum mass flow

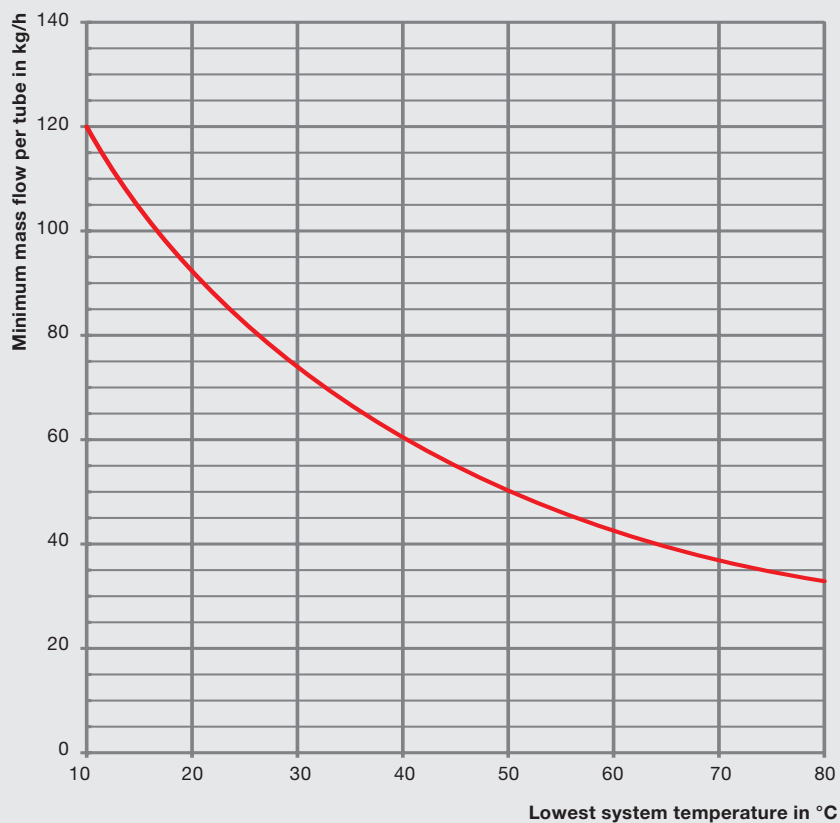

Inclination

Depending on the design of the room, radiant ceiling panels can be inclined in the lateral or longitudinal direction.

Inclining the radiant ceiling panel increases the output according to the formula $\dot{Q}_g = \dot{Q} \cdot s$.

This increase in output must be taken into account accordingly when calculating the mass flow. The maximum permitted angles of inclination depend on the suspension technology.

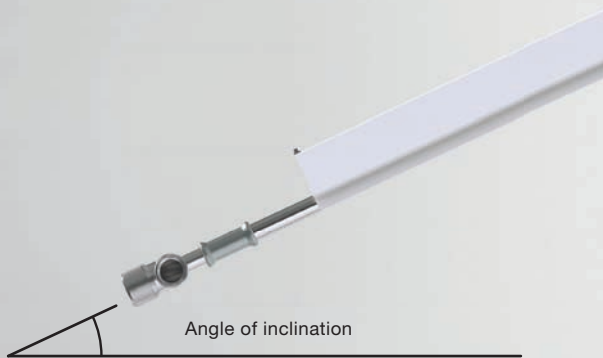

Radiant ceiling panel inclined in the longitudinal direction



Radiant ceiling panel inclined in the lateral direction

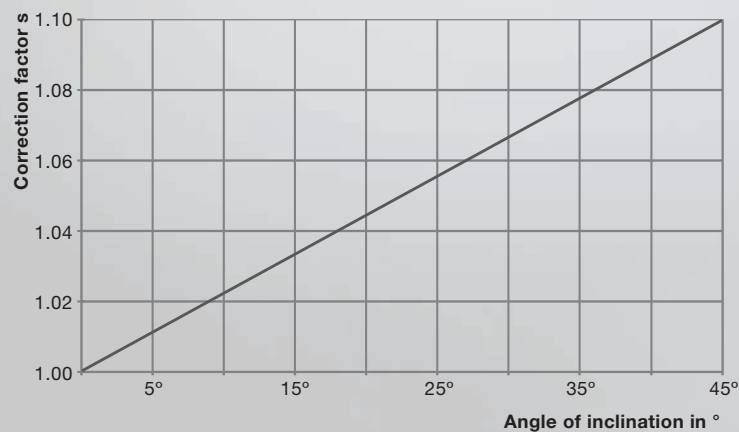

Increase in total thermal output \dot{Q}_g with inclined radiant ceiling panel

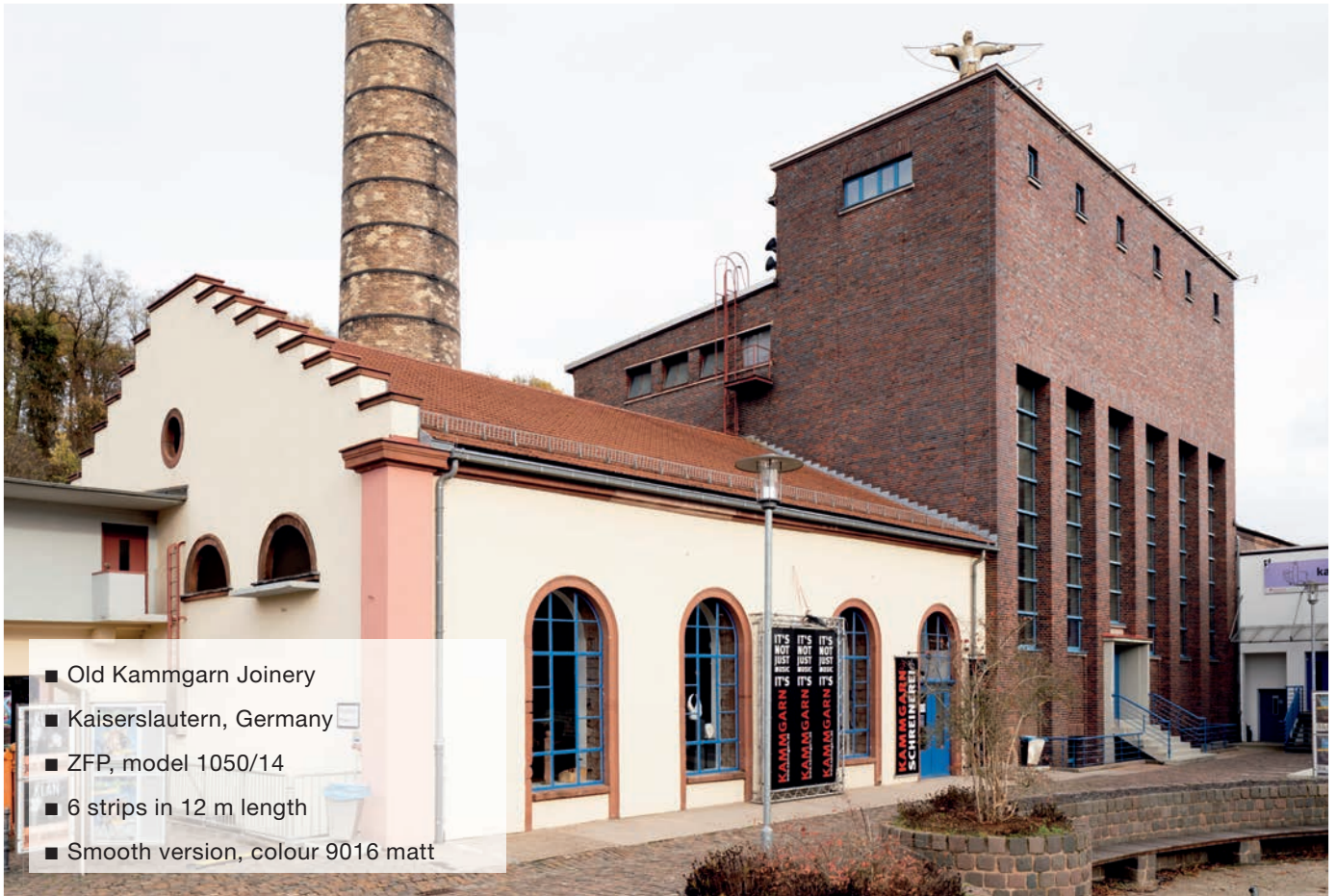

- Old Kammgarn Joinery
- Kaiserslautern, Germany
- ZFP, model 1050/14
- 6 strips in 12 m length
- Smooth version, colour 9016 matt

Basic information

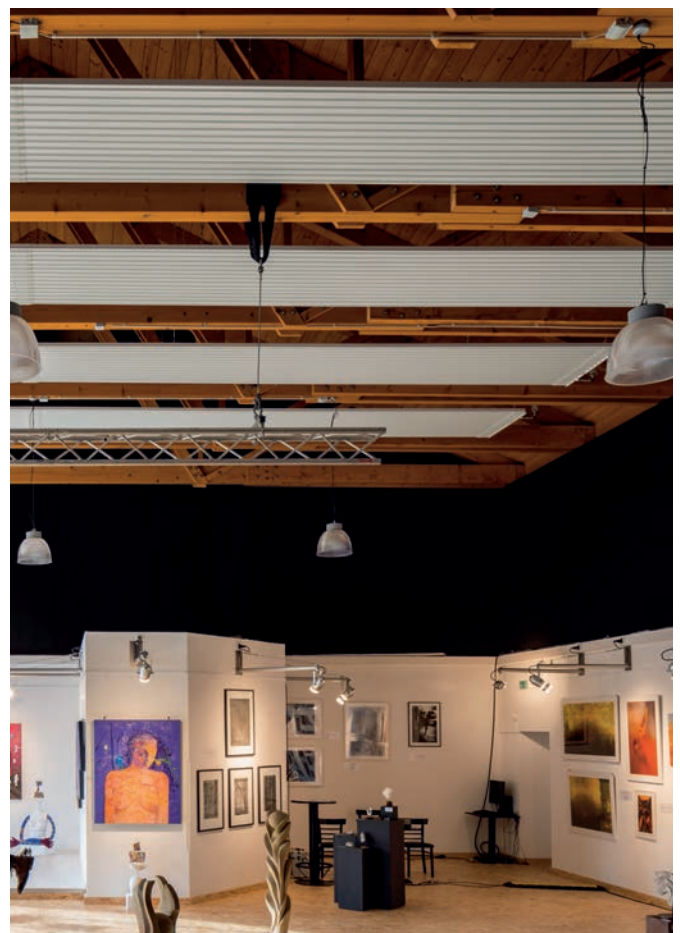

Structure and dimensions

Structure of the module

A galvanised steel sheet with Zehnder special clip profiling forms the basis of the Zehnder ZFP radiant ceiling panel. Four to twenty externally galvanised precision steel tubes, suspension axes and the top thermal insulation are then embedded. The radiant ceiling panel is optimally statically reinforced using chamfers, special duplications, clinched joints and edgings.

Zehnder ZFP radiant ceiling panels are supplied with a smooth or perforated design. The surface is galvanised and also coated with a high-quality polyester paint (similar to RAL9016 matt).

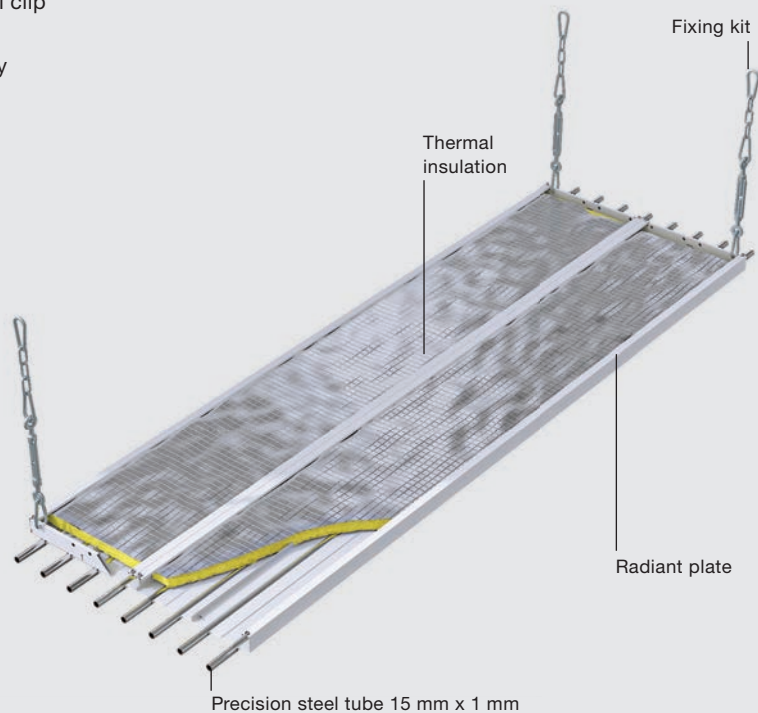

Design

Zehnder ZFP modules are 300 to 1,500 mm wide.

In terms of length, Zehnder ZFP modules are available in metre increments from 2 m to 6 m. The individual modules can be connected together using crimp connections or threaded connections to form one radiant ceiling panel strip. The connection points are hidden with cover plates.

Special lengths are available on request.

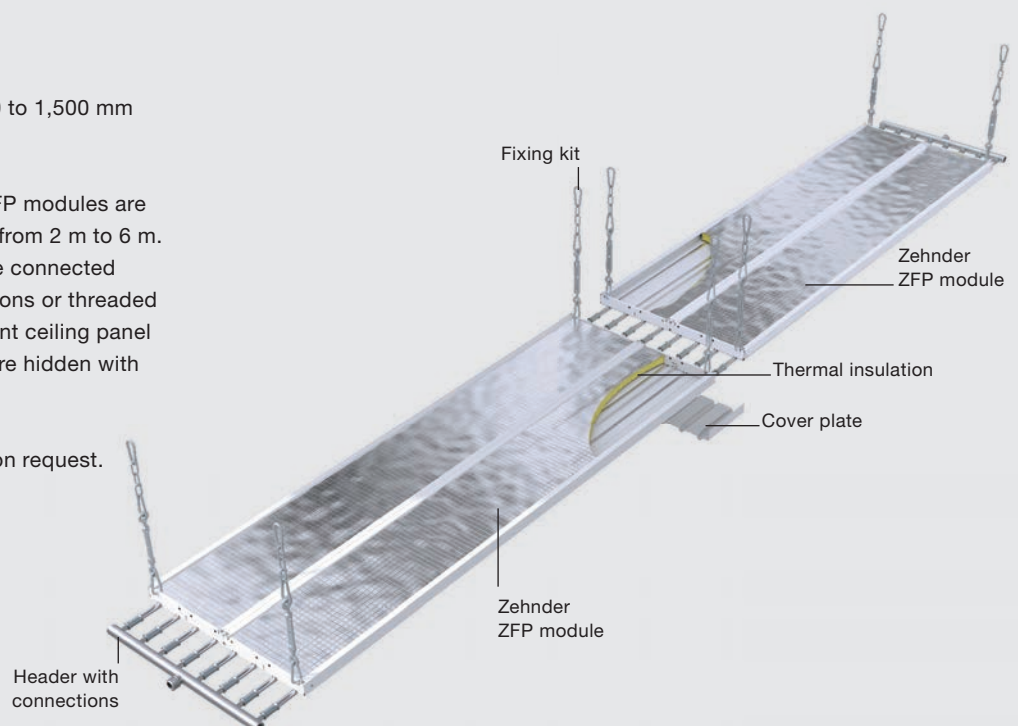

Standard lengths

Zehnder ZFP modules are available in standard lengths of 2, 3, 4, 5 and 6 m. For longer strips, multiple modules can be connected in series.

Special lengths are available on request.

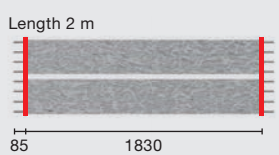
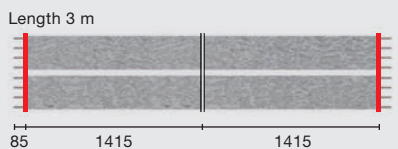
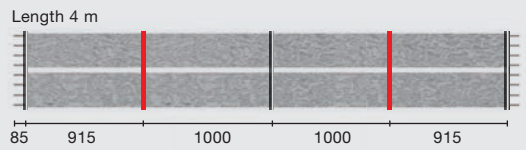
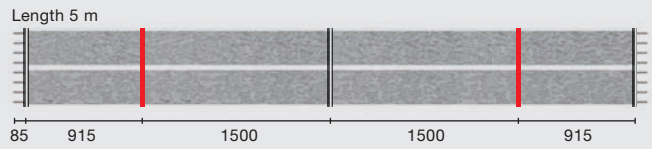
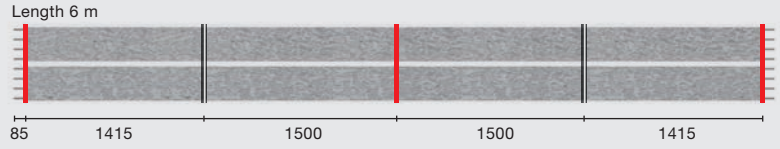

- Suspension axis¹⁾
- Reinforcement axis (optional suspension axis)

¹⁾ 2 suspension points per axis, for all widths

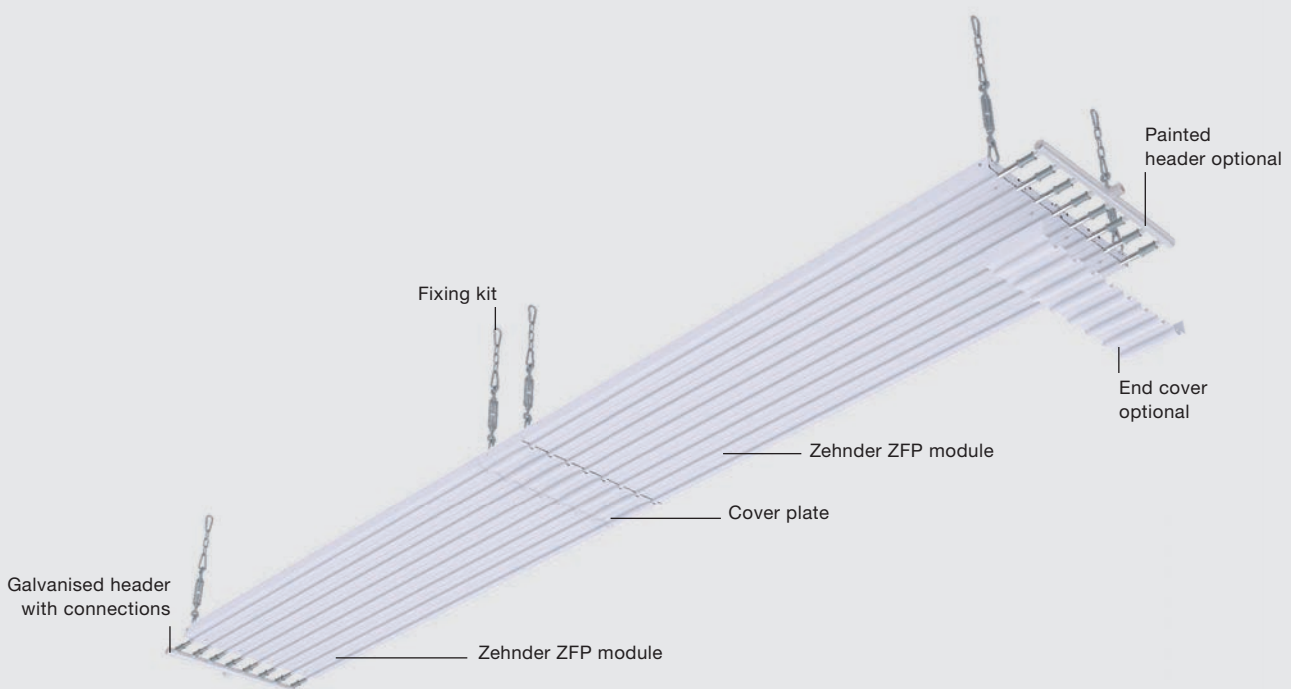

Combination options

Suspension as first panel in strip

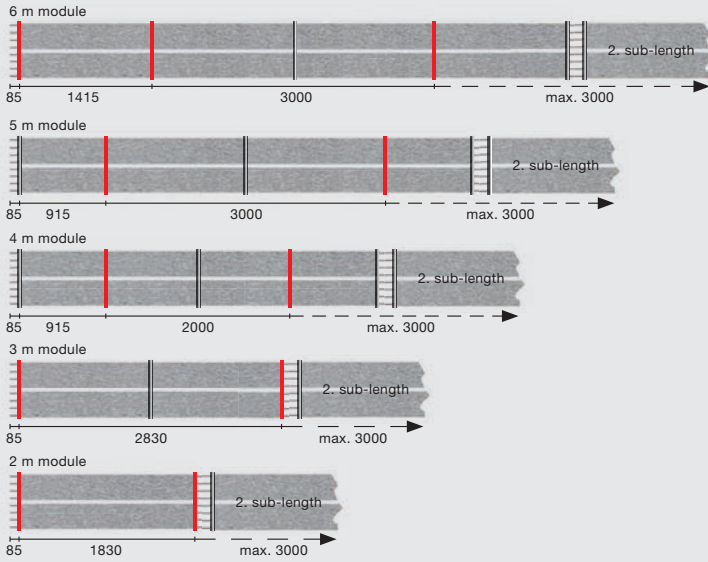

Suspension in the middle of the strip

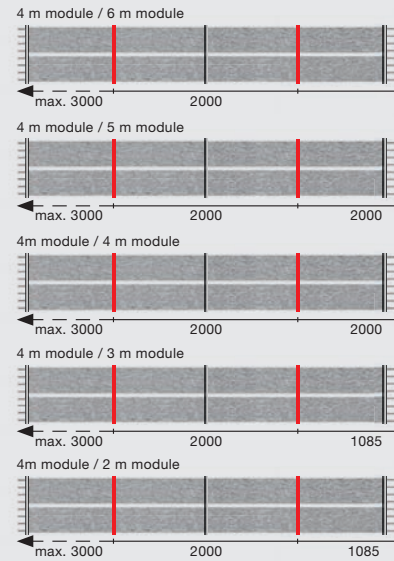
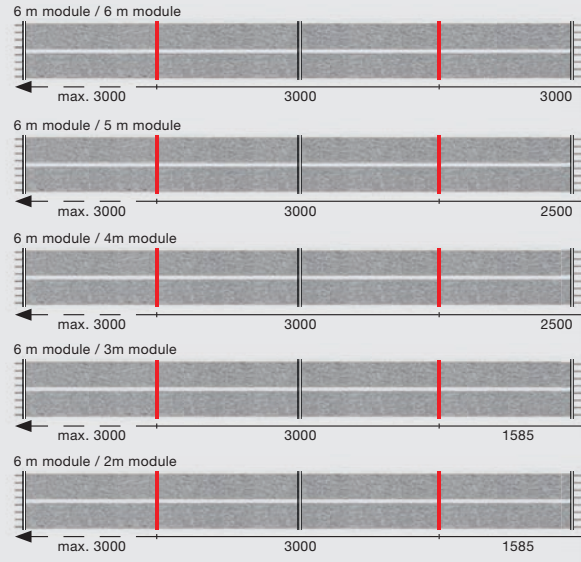

Arrangement within strip

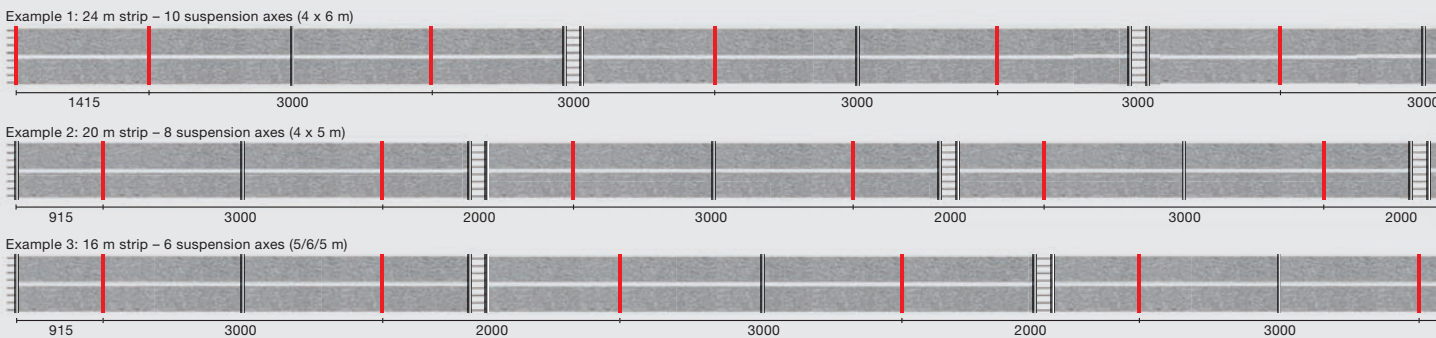

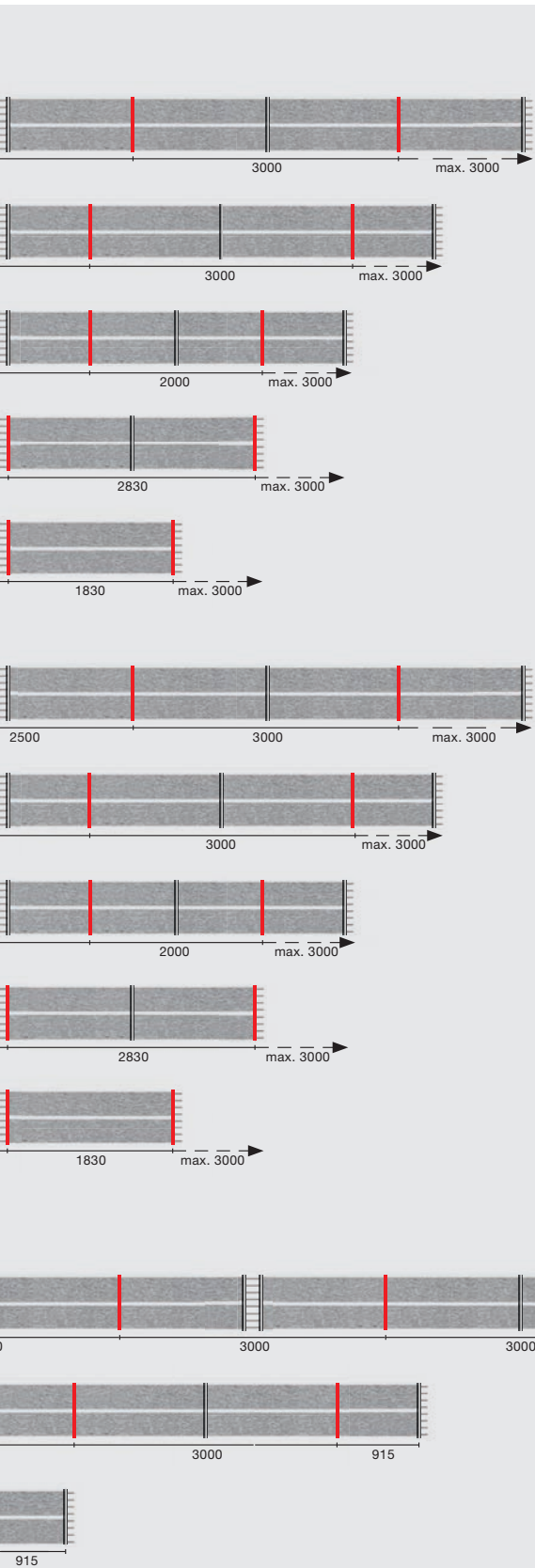

Suspension as final panel in strip

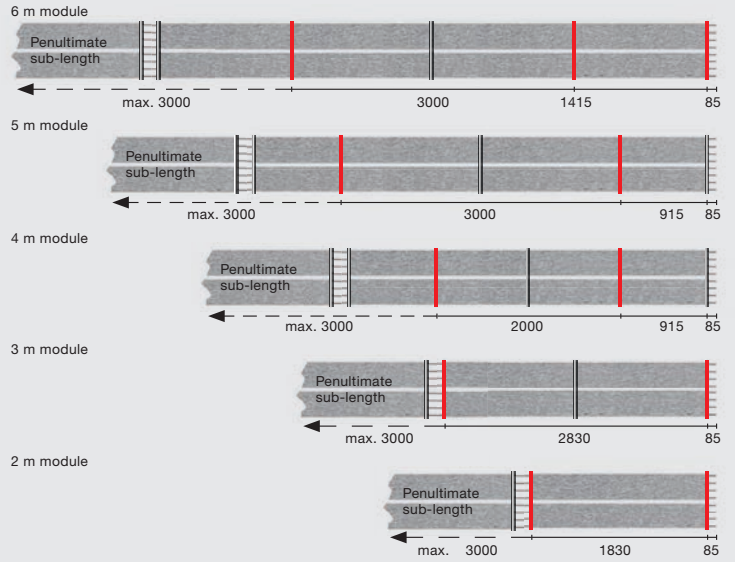

- Suspension axis¹⁾
- Reinforcement axis (optional suspension axis)

¹⁾ 2 suspension points per axis, for all widths

Module dimensions

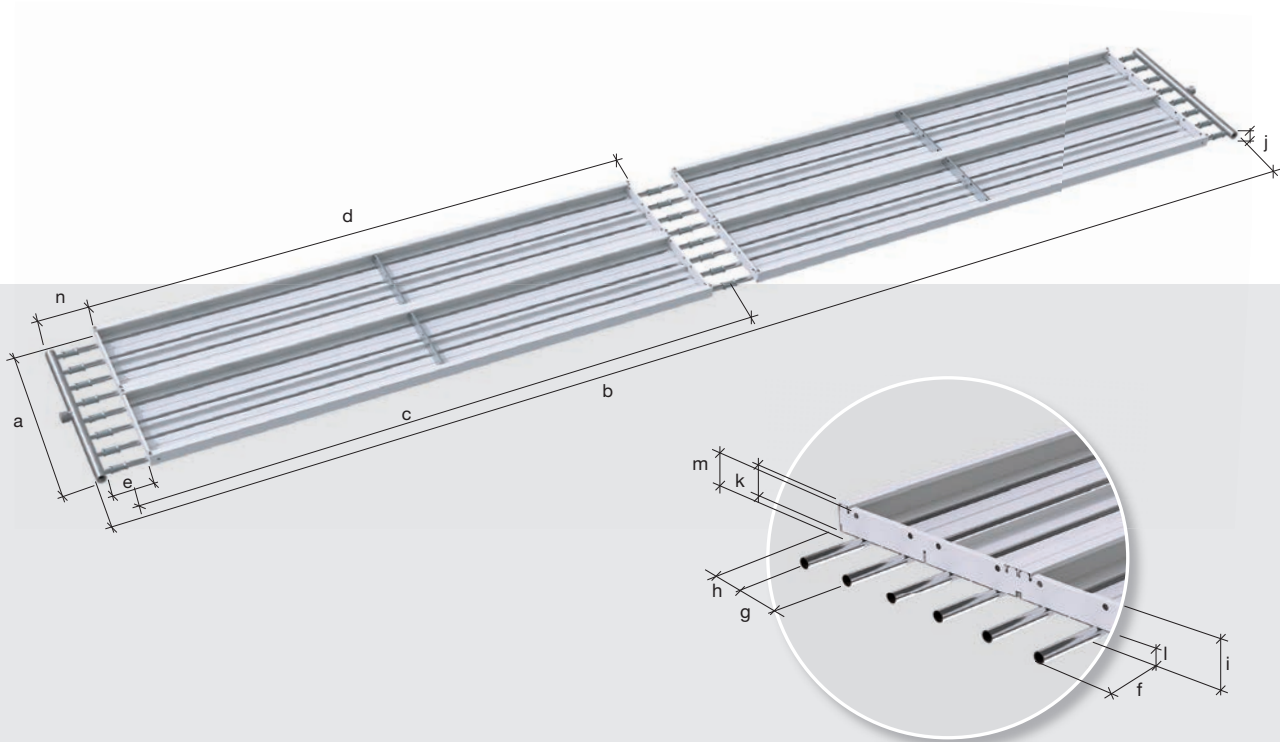

Module dimensions

Item	Description	Dimension in mm	Min. dimension in mm	Max. dimension in mm	Note
a	Overall width	Variable	300	1,500	Grid size: 150 mm
b	Overall length (without connections)	Variable	2,140	- ¹⁾	Grid size: 1,000 mm
c	Length of individual element/length of pipe	Variable	2,000	6,000	Grid size: 1,000 mm
d	Radiant plate length of individual section	Variable	1,830	5,830	Grid size: 1,000 mm
e	Distance from module end to collector tube	125	-	-	-
f	Tube projection	85	-	-	-
g	Distance from tube centre to tube centre	75	-	-	-
h	Distance from pipe to side lip	37.5	-	-	-
i	Overall height (without suspension)	55	-	-	-
j	Diameter of header	30	-	-	-
k	Height of side lip	42	-	-	-
l	Height of pipe beading	13	-	-	-
m	Upper edge of suspension point to lower edge of pipe beading	49	-	-	-
n	Pipe projection including manifold pipe	155	-	-	-

¹⁾The maximum possible overall length of the Zehnder ZFP strip depends on the operating conditions and the permitted pressure loss.

Connector technology

The Zehnder ZFP modules are assembled into the desired configuration by means of press-fit or threaded connections and the connection points are then hidden under a cover plate. Galvanised headers are supplied.

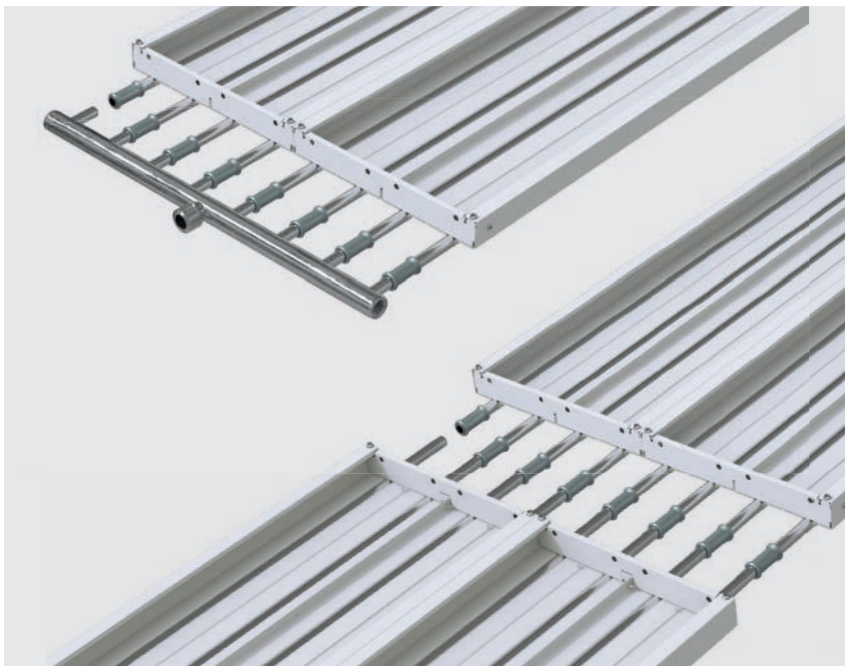

Crimp connection

Article no. 502280

Max. operating temperature: 120 °C

Max. operating pressure: 12 bar

Fitting length: 48 mm



Threaded connection

Article no. 633010

Max. operating connection: 95 °C

Max. operating pressure: 5 bar

Fitting length: 66 mm

Headers and collectors

The galvanised/galvanised and painted headers and collectors are pressed or bolted together with the externally galvanised tubes (as per DIN EN 10305-3) of the Zehnder ZFP modules.

Collector 20
514350¹ / 514610²



Collector 18
514340¹ / 514600²

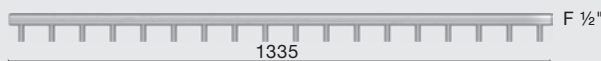

Collector 16
514330¹ / 514590²

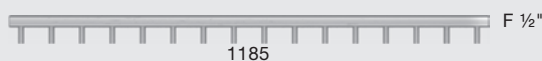

Collector 14
514320¹ / 514580²

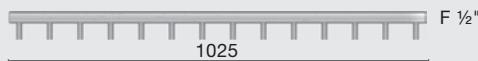

Collector 12
514310¹ / 514570²



Collector 10
514300¹ / 514560²

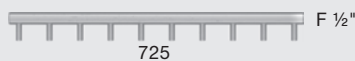

Collector 9
514290¹ / 514550²

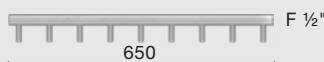

Collector 8
514280¹ / 514540²

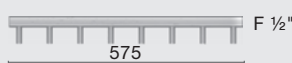

Collector 7
514270¹ / 514530²



Collector 6
514260¹ / 514520²

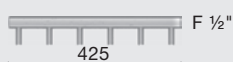

Collector 5
514250¹ / 514510²



Collector 4
514240¹ / 514500²

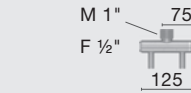
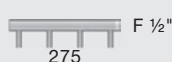

Connection size of header
Header 2
514100¹ / 514360²
Outer size of header

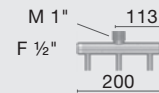

Connection size of header
Header 3
514110¹ / 514370²
Outer size of header

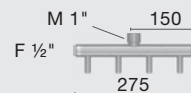

Connection size of header
Header 4
514120¹ / 514380²
Outer size of header

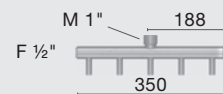

Connection size of header
Header 5
514130¹ / 514390²
Outer size of header

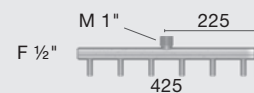

Connection size of header
Header 6
514140¹ / 514400²
Outer size of header

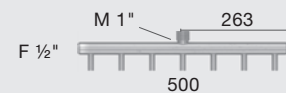

Connection size of header
Header 7
514150¹ / 514410²
Outer size of header

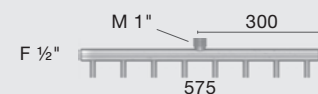

Connection size of header
Header 8
514160¹ / 514420²
Outer size of header

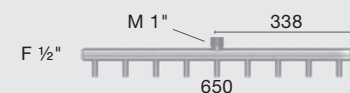

Connection size of header
Header 9
514170¹ / 514430²
Outer size of header

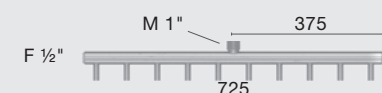

Connection size of header
Header 10
514180¹ / 514440²
Outer size of header



Connection size of header
Header 12
514190¹ / 514450²
Outer size of header

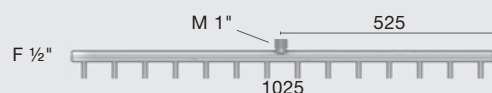

Connection size of header
Header 14
514200¹ / 514460²
Outer size of header

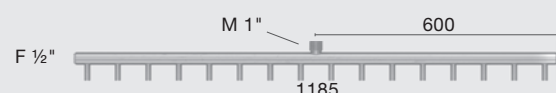

Connection size of header
Header 16
514210¹ / 514470²
Outer size of header

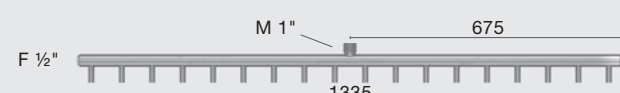

Connection size of header
Header 18
514220¹ / 514480²
Outer size of header

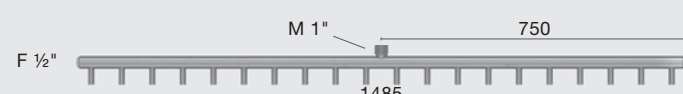

Connection size of header
Header 20
514230¹ / 514490²
Outer size of header

F = female thread

M = conical male thread

Zehnder accepts no liability for the use of other connections.

¹ Article number for galvanised finish

² Article number for painted finish

Maximum flexibility – example of water channels for model 600/8

Water channels at opposite ends

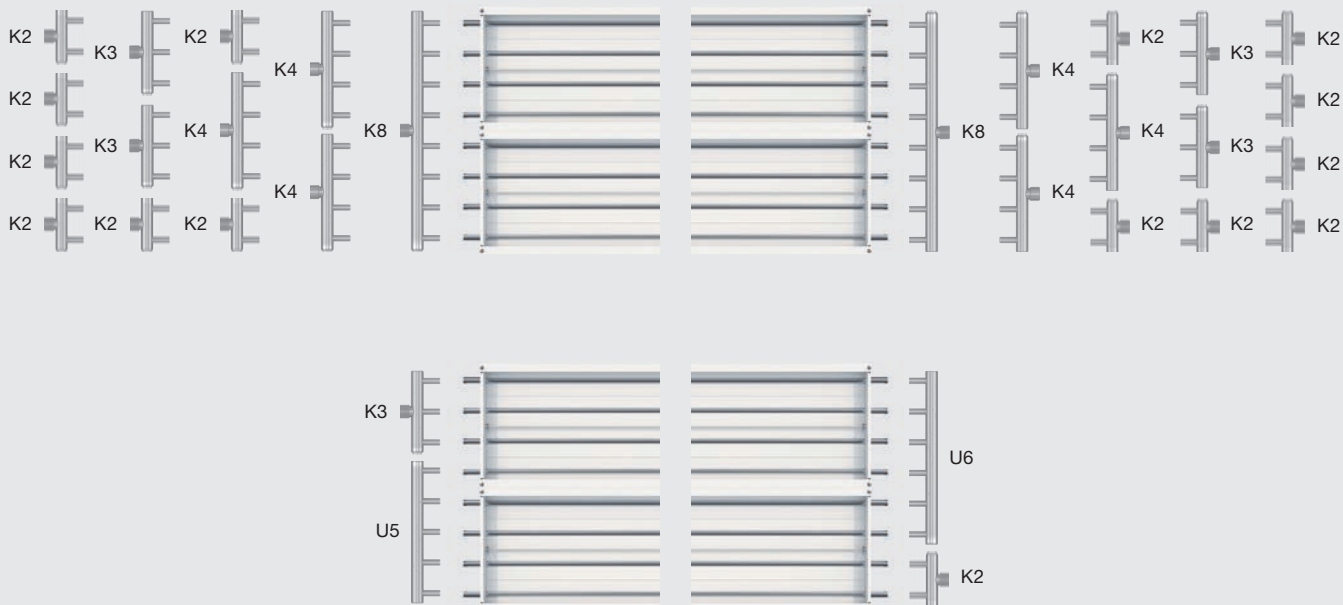

Water channels at the same end

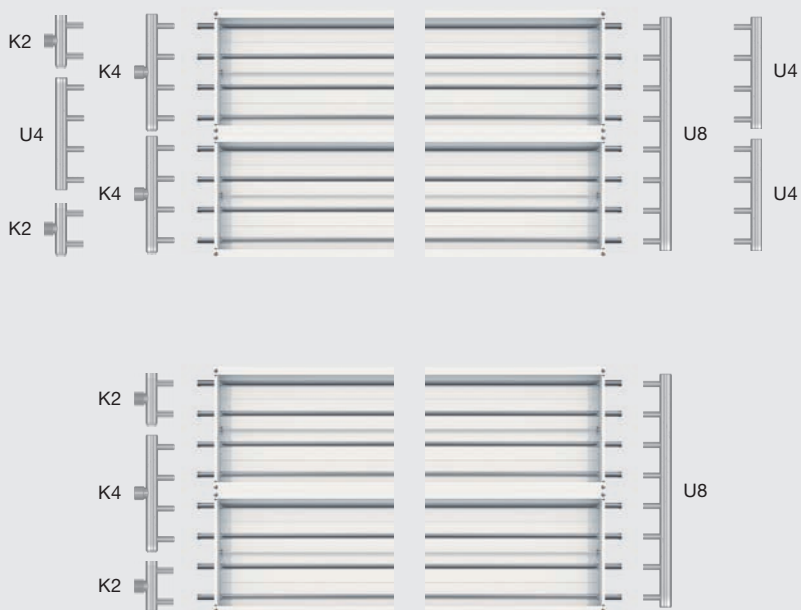

Layout basics

The heat load of the room is calculated according to the applicable standard. If the transmission heat loss through the roof is over 30% of the total heat load, this indicates that significant heat loss is occurring in the ceiling area. If the roof's insulation cannot be improved, the thermal insulation on top of the radiant ceiling panels can be removed proportionately instead, thus compensating for the considerable amount of transmission heat loss through the roof. If the air exchange rate of a room is above the usual level achieved with gap ventilation (max. 1 1/h), particularly with extraction systems, the air fed into the room must be pre-heated. Radiant heating systems alone cannot prevent infiltration of cold air at doors or loading areas. Strip curtains or air curtains, for example, must be used to help rectify this situation.

Example of layout and arrangement

The following example shows the layout of a sports hall.

Objective

Even indoor temperature
(20 °C) throughout the entire room.

Specifications

Free-standing hall:
Length 100 m, width 30 m, height 8 m
Air exchange: 0.3 1/h
Outdoor temperature: -12 °C

Heat load

Design transmission heat loss:	108500 W
Design ventilation heat loss:	77260 W
Design heat loss:	<u>185760 W</u>

Layout of the radiant ceiling panels

Flow temperature: 80 °C
Return temperature: 70 °C

Arrangement

- Five radiant panel strips arranged length-wise, divided into sections in the centre, uniform centre-to-centre distance of 7.2 m, outer strips dimensioned greater than inner ones.
- One strip at each face end, divided into sections; distance from strips to outer walls 1.5 m.

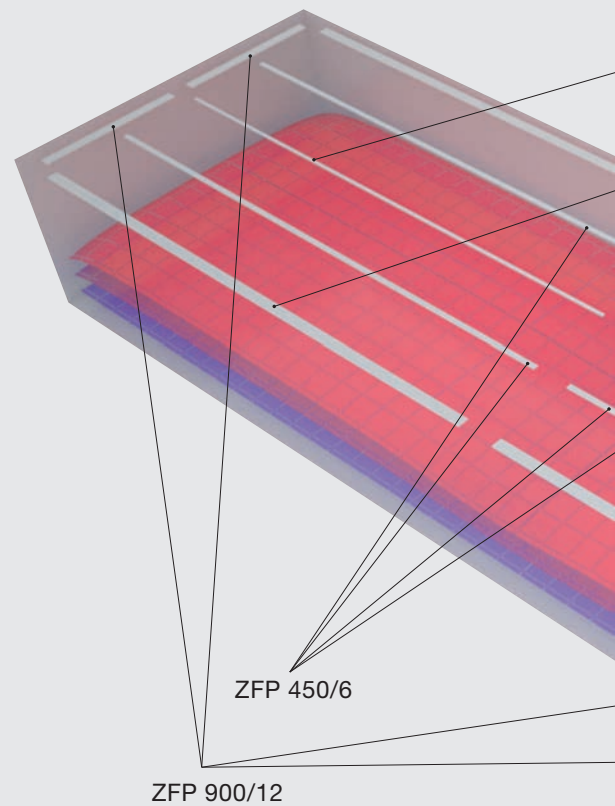

Thermal output calculation

Type	Length in m	Excess temperature in K	Output in W/m	Output in W/manifold pair	Quantity	Total thermal output in W
ZFP 900/12	13	55	512	201	4	27446
ZFP 900/12	44	55	512	201	4	90973
ZFP 450/6	44	55	283	92	4	50197
ZFP 300/4	44	55	202	55	2	17880

186497 W

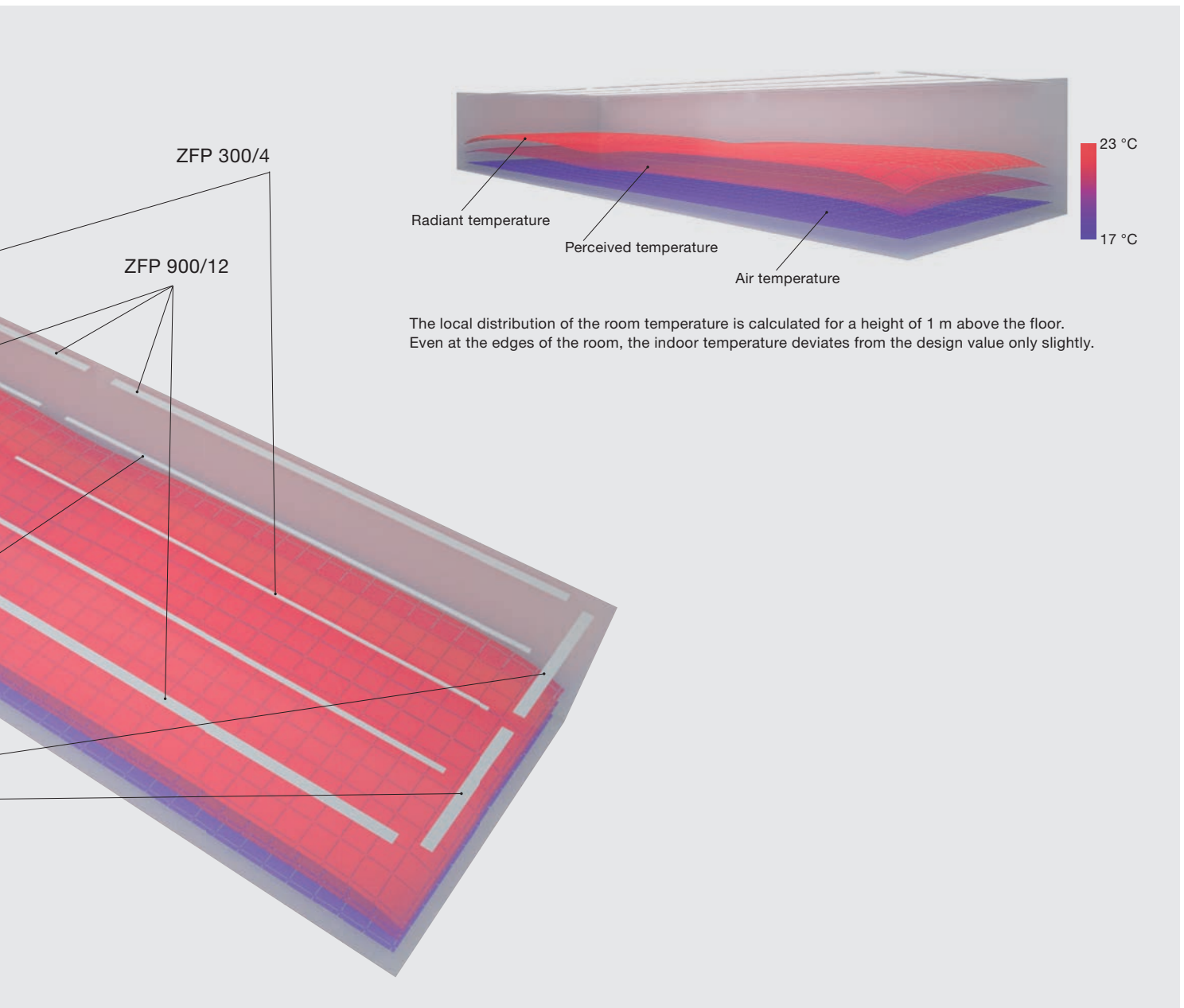

Pressure loss calculation

The total pressure loss for Zehnder ZFP radiant ceiling panels is calculated as a total of the pressure loss in the tube and the pressure loss in the headers. When using Zehnder volume flow controllers, the additional pressure loss incurred should be added to this.

Pressure loss of the pair of headers including connections

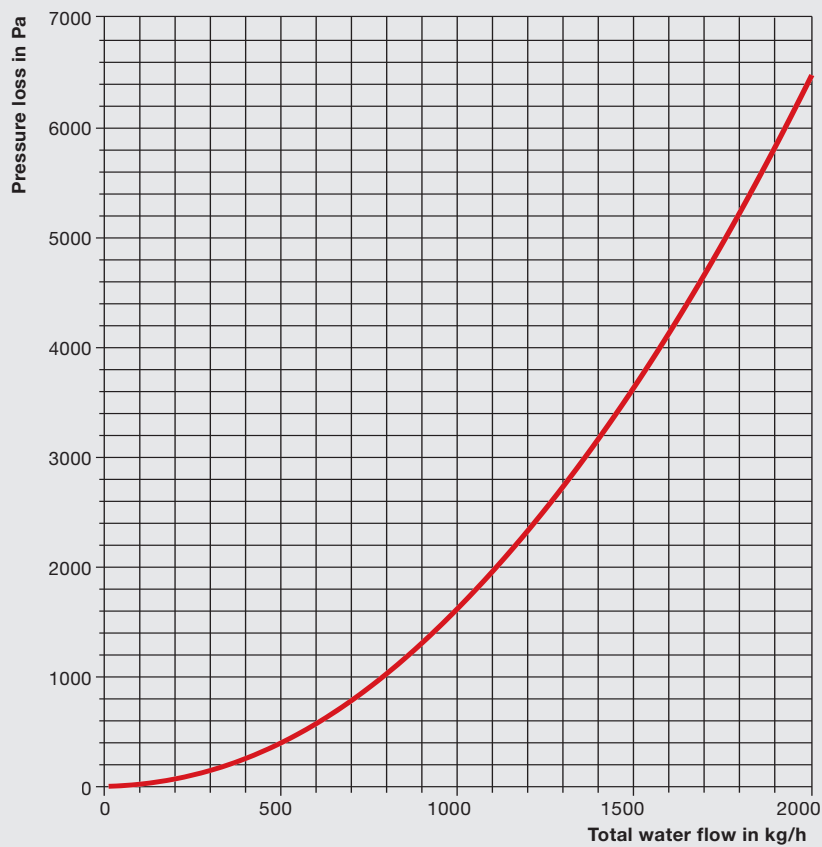

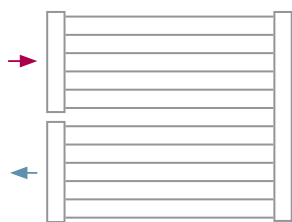
Determining the pressure loss:

e.g. ZFP 900/12, 13 m

1. Calculate total mass flow of the radiant ceiling panel in question.

Calculation formula:

$$\dot{m} = (\dot{Q} * 0,86) / \Delta T$$

\dot{Q} = Output (W)

ΔT = spread (K)

\dot{m} = mass flow (kg/h)

For the example on page 26 (for a 900/12; 13 m), the following therefore applies:
 $\dot{m} = (6,861 \text{ W} * 0.86) / 10 \text{ K} = 590 \text{ kg/h}$

2. Refer to the graph for the pressure loss of the pair of headers.

e.g. $\Delta p = 600 \text{ Pa}$ /pair of headers. Since the heating water flows into and out of a header twice, the value should be multiplied by two.

3. Refer to the graph for the pressure loss of the tube. The mass flow is calculated by dividing the total mass flow by the number of tubes with parallel flow.

e.g. $590 \text{ kg/h} : 6 \text{ tubes (6 each for flow and return)} = 98 \text{ kg/h}$

$\Delta p = 65 \text{ Pa/m} * 13 \text{ m} * 2$
 (for flow and return) = 1,690 Pa

4. The total pressure loss for the radiant ceiling panel is the sum of the individual pressure losses calculated previously.

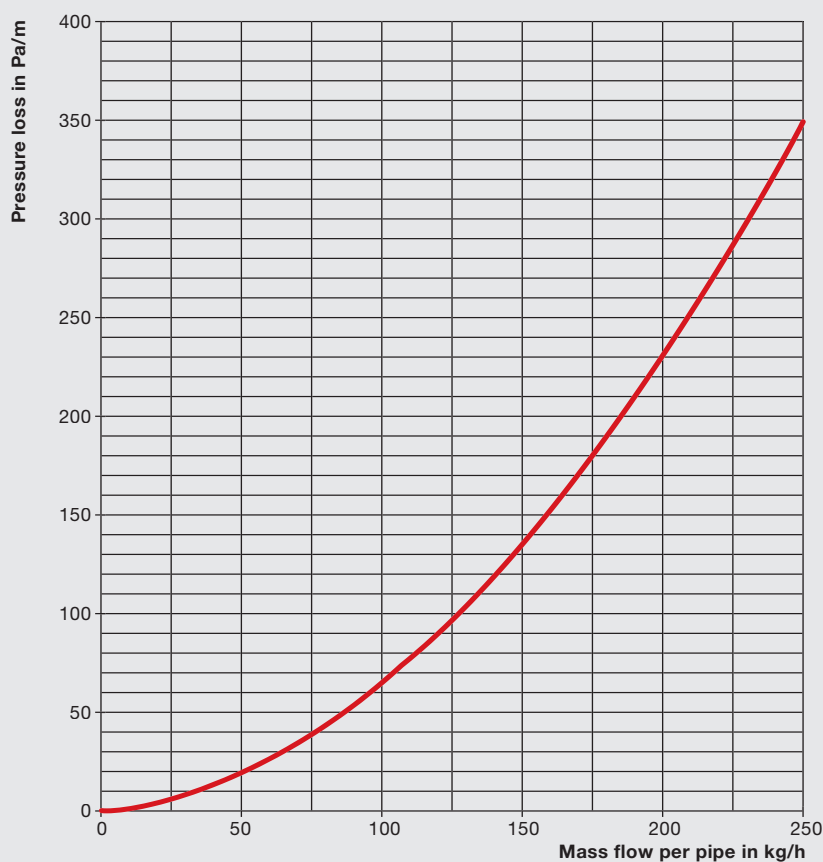
Pressure loss per tube

Hydraulic balancing of radiant ceiling panels

The correct water flow distribution for the heating water flow is important for operating any branched heating or cooling system efficiently. (it must also be possible to fill, shut off and empty all radiant ceiling panel strips separately).

For systems where the radiant ceiling panels and the volume flows are identical, laying pipes according to the Tichelmann system will provide a perfect hydraulic solution. However, the third pipe results in a considerable increase in costs where space heating systems are concerned and is not advisable in many instances if panels of different sizes are used.

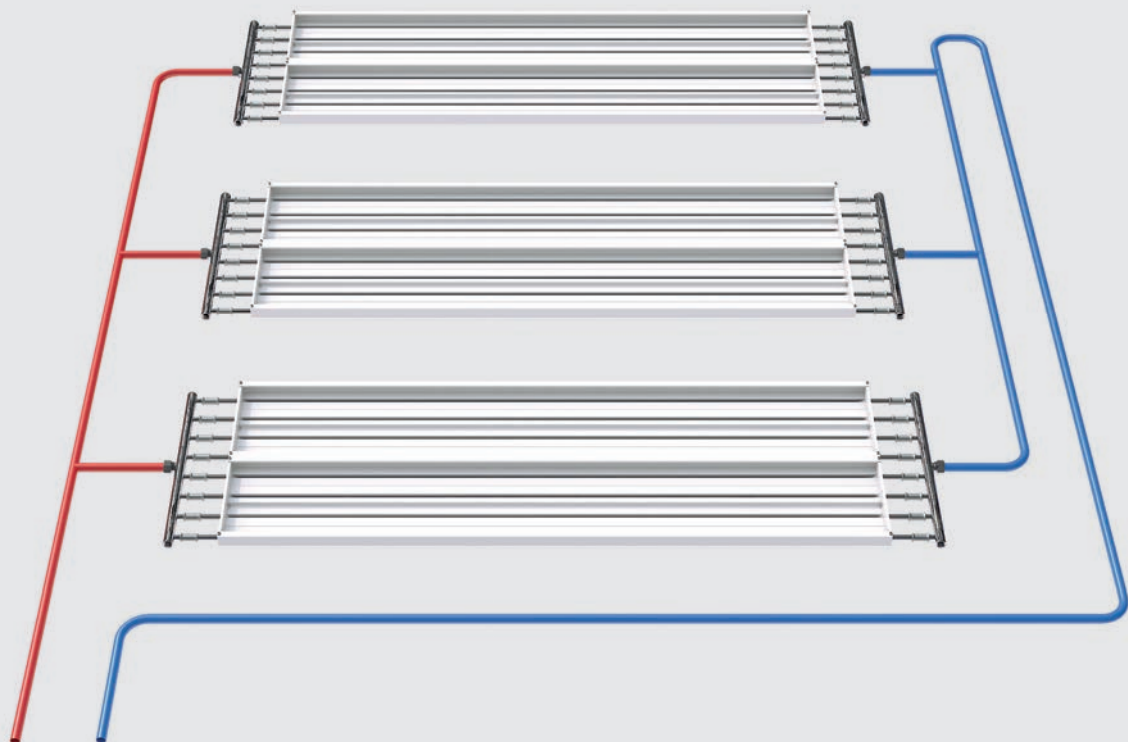

Fig. 1: Pipes laid according to the Tichelmann system (two-pipe system with reverse return)

Systems where the individual strips have different outputs must be subjected to hydraulic balancing by means of the pipework design and adjustments. This process, however, demands a large investment in terms of time and money. Hydraulic balancing is made easier with the Zehnder volume flow control combination (VSRK) (Fig. 2).

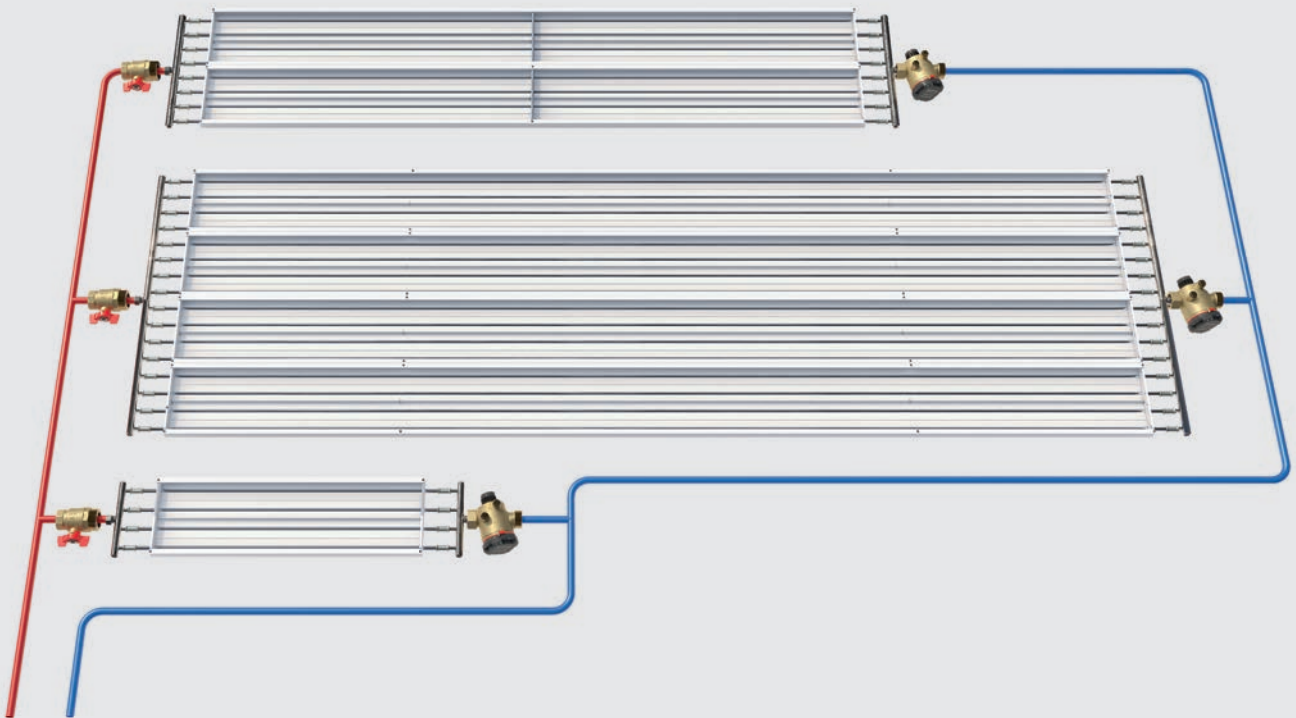

Fig. 2: Simplified pipe layout with Zehnder volume flow control combination (VSRK)

Volume flow control combination

The VSRK is a complete set consisting of a volume flow controller and ball cocks. The controller is set to the volume flow of the strip ex works. This removes the need for any time-consuming adjustment work on-site.

Other advantages of the VSRK:

- Constant volume flow even when there is a high differential pressure
- Hydraulic balancing even for radiant panels of different sizes

Longer radiant panel systems must have a flexible connection (armoured hose).

The Zehnder volume flow control combination is suitable for an operating temperature of -10 °C up to a maximum of 120 °C and a maximum operating pressure of 16 bar. The working condition is permitted for the following medium: Water and ethylene/propylene glycol water mix (max. 50%), pH value 6.5–10.

Article numbers:

VSRK-15 combination, 30–210 kg/h	513800
VSRK-15 combination, 150–700 kg/h	513810
VSRK-25 combination, 300–2,000 kg/h	513820
VSRK-32 combination, 600–3,600 kg/h	513830
VSRK Special 15/15/15, 30–210 kg/h	513840
VSRK Special 15/15/15, 150–700 kg/h	513850
VSRK Special 25/15/15, 300–2,000 kg/h	513860
VSRK Special 25/25/25, 300–2,000 kg/h	513870
VSRK Special 32/25/25, 600–3,600 kg/h	513880
VSRK Special 32/32/32, 600–3,600 kg/h	513890
Controller, separate DN15, 30–210 kg/h	513900
Controller, separate DN15, 150–700 kg/h	513910
Controller, separate DN25, 300–2,000 kg/h	513920
Controller, separate DN32, 600–3,600 kg/h	513930
Flow, separate DN15	513940
Flow, separate DN25	513950
Flow, separate DN32	513960
Armoured hose DN15	509260 / 513430
Armoured hose DN25	509280 / 513440
Armoured hose DN32	509310 / 513450
Reducing sleeve 1" x ½"	501170
Sleeve 1"	501190
Reducing sleeve ¾" x 1"	501180
Coupler screw connection ¾" x ½"	514000

DN15				DN25		DN32	
30–210 kg/h		150–700 kg/h		300–2,000 kg/h		600–3,600 kg/h	
Mass flow (kg/h)	Minimum differential pressure (kPa)	Mass flow (kg/h)	Minimum differential pressure (kPa)	Mass flow (kg/h)	Minimum differential pressure (kPa)	Mass flow (kg/h)	Minimum differential pressure (kPa)
30	10.0	150	13.0	300	15.0	600	15.0
60	10.8	200	13.5	350	15.3	700	15.3
90	11.7	250	13.9	400	15.6	800	15.7
120	12.5	300	14.4	450	15.9	900	16.0
150	13.3	350	14.8	500	16.2	1,000	16.3
180	14.2	400	15.3	550	16.5	1,100	16.7
210	15.0	450	15.7	600	16.8	1,200	17.0
		500	16.2	650	17.1	1,300	17.3
		550	16.6	700	17.4	1,400	17.7
		600	17.1	750	17.6	1,500	18.0
		650	17.5	800	17.9	1,600	18.3
		700	18.0	850	18.2	1,700	18.7
				900	18.5	1,800	19.0
				950	18.8	1,900	19.3
				1,000	19.1	2,000	19.7
				1,050	19.4	2,100	20.0
				1,100	19.7	2,200	20.3
				1,150	20.0	2,300	20.7
				1,200	20.3	2,400	21.0
				1,250	20.6	2,500	21.3
				1,300	20.9	2,600	21.7
				1,350	21.2	2,700	22.0
				1,400	21.5	2,800	22.3
				1,450	21.8	2,900	22.7
				1,500	22.1	3,000	23.0
				1,550	22.4	3,100	23.3
				1,600	22.6	3,200	23.7
				1,650	22.9	3,300	24.0
				1,700	23.2	3,400	24.3
				1,750	23.5	3,500	24.7
				1,800	23.8	3,600	25.0
				1,850	24.1		
				1,900	24.4		
				1,950	24.7		
				2,000	25.0		

Connection size for Zehnder volume flow control combinations

VSRK dimensions	Controller or ball valve		Flat-sealing coupler screw connection	Male thread of hose	Female thread of straight connector	Female thread of straight connector	Conical male thread of header
	A	B	C	D	E	F	G
DN15 (30–210 kg/h)	Rp 1/2"	G 3/4"	Rp 3/4"	R 1/2"	Rp 1/2"	R 1"	R 1"
DN15 (150–700 kg/h)	Rp 1/2"	G 3/4"	Rp 3/4"	R 1/2"	Rp 1/2"	R 1"	R 1"
DN25 (300–2,000 kg/h)	Rp 1"	G 1 1/4"	Rp 1 1/4"	R 1"	Rp 1"	R 1"	R 1"
DN32 (600–3,600 kg/h)	Rp 1 1/4"	G 1 1/2"	Rp 1 1/2"	R 1 1/4"	Rp 1 1/4"	R 1"	R 1"

**Example of VSRK-15 (150–700 kg/h):
Return**

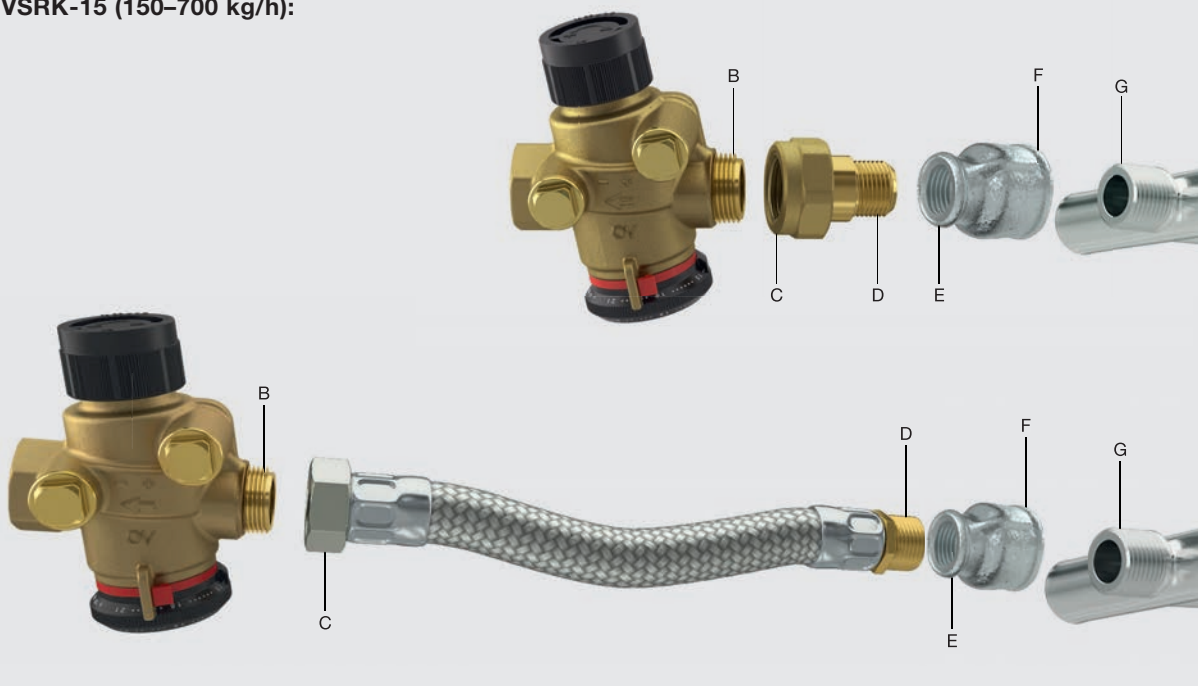

**Example of VSRK-15 (150–700 kg/h):
Flow**

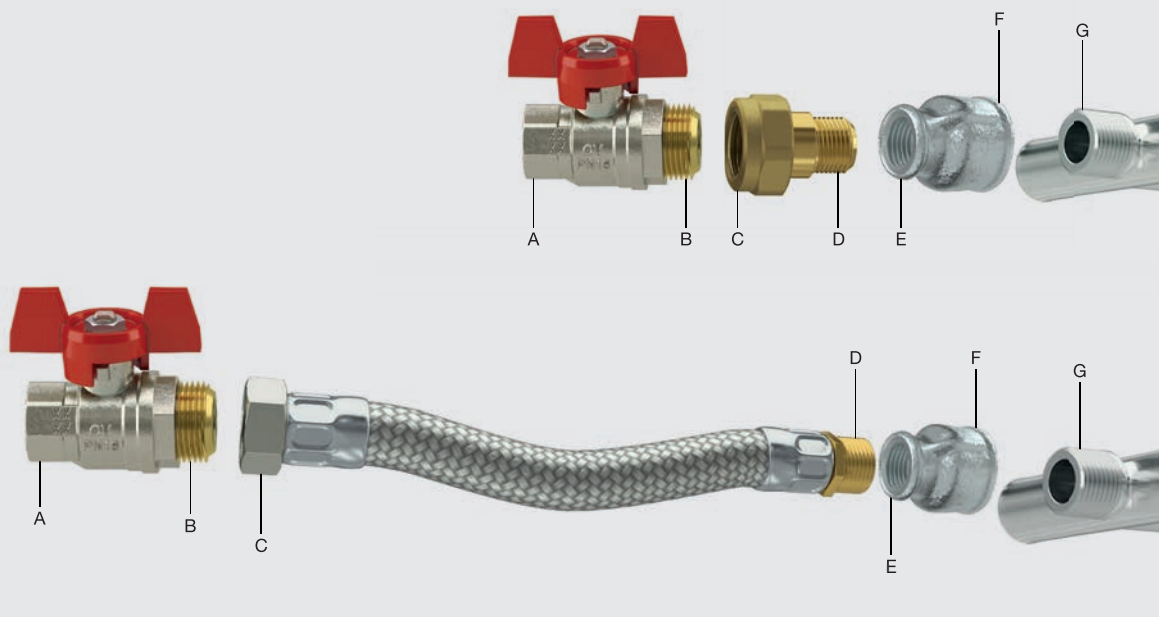

Standard colour / special colour

The surfaces of Zehnder heating and cooling ceiling modules are coated with a high-quality powder coat finish. Our standard Zehnder ZFP radiant ceiling panels are similar to RAL 9016 matt. Alternatively, you can choose from over 700 colours.

We would be delighted to review your enquiry – please get in touch.

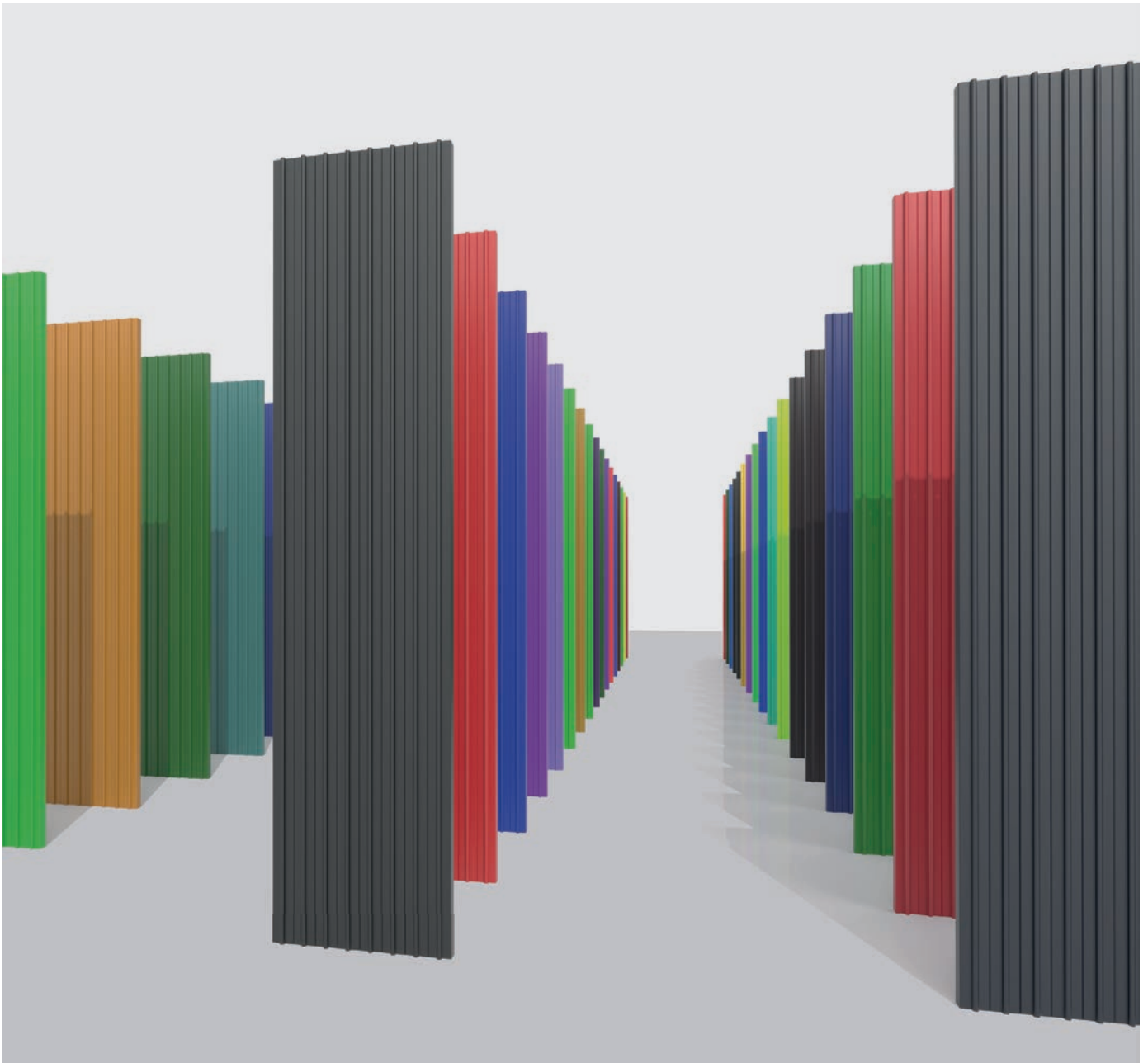

Thermal insulation

When radiant ceiling panels are used, insulation on top of the panels is recommended. Zehnder offers a suitable option for every application – fitted ex works. This saves valuable time during on-site installation.

Aluminium-laminated mineral wool

Application:

Zehnder ZFP for heating, smooth version

Mineral wool exempt according to EU Directive 97/69 (note Q); lined with aluminium grille on one side
 $\lambda = 0.038 \text{ W/mK}$, thickness 40 mm

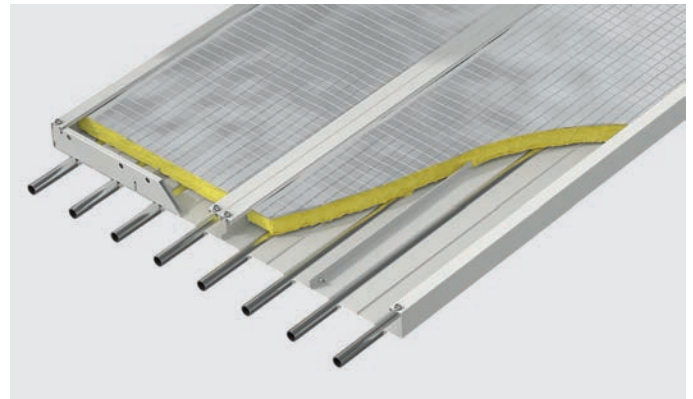

Mineral wool shrink-wrapped in foil

Application:

Zehnder ZFP for heating and cooling, smooth and perforated versions

Mineral wool exempt according to EU Directive 97/69 (note Q), lined with black fleece and shrink-wrapped in LDPE foil
 $\lambda = 0.040 \text{ W/mK}$, thickness 40 mm

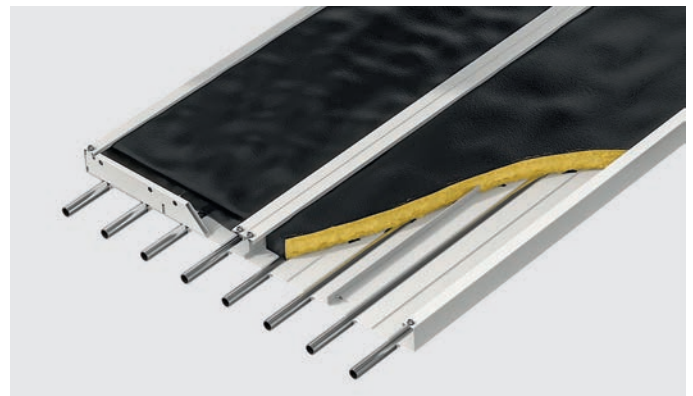

Acoustic insulation

Application:

Zehnder ZFP for heating, perforated version

Mineral wool, coated with glass mat on both sides (one side white/one side black)
 $\lambda = 0.035 \text{ W/mK}$, thickness 40 mm



Perforation and acoustics

Zehnder ZFP radiant ceiling panels in perforated design are used not only for heating and cooling, but also for sound absorption.

The sound waves pass through the perforated surface of the radiant panel sheet into the thermal insulation, where they are absorbed. This results in a significant reduction of the noise level or a reduction in the reverberation time (in sport and event halls, for example).

The perforated design of the Zehnder ZFP is a visual highlight, too.



Hole pattern

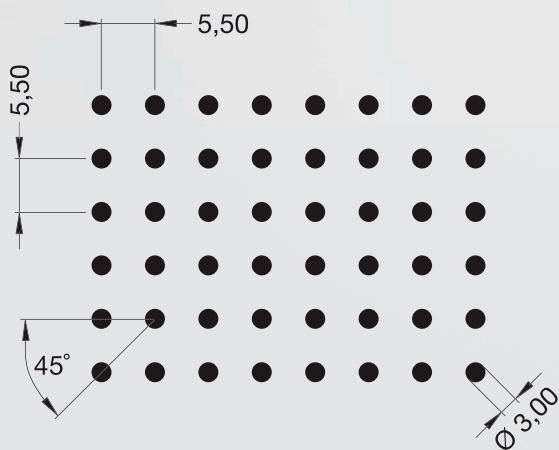

The Zehnder ZFP in perforated design has a free cross section of ~ 13.6%

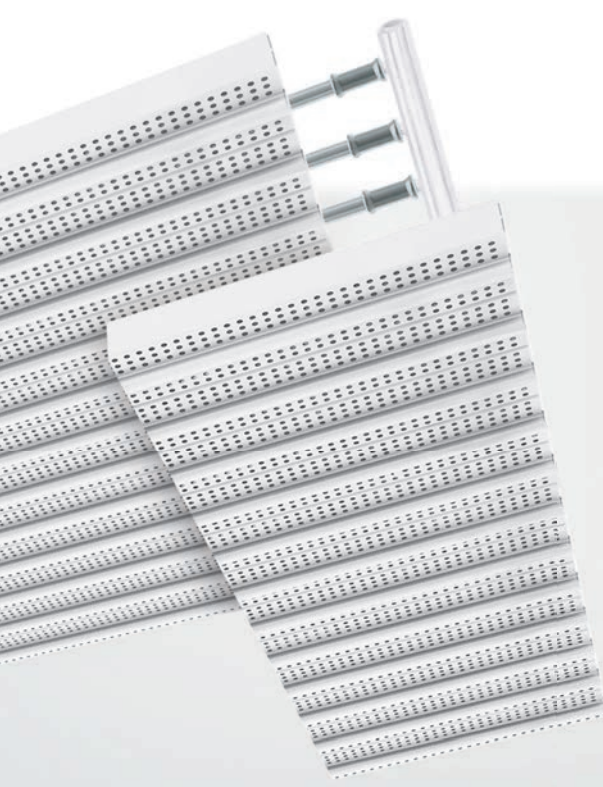

ZFP in perforated version with acoustic insulation

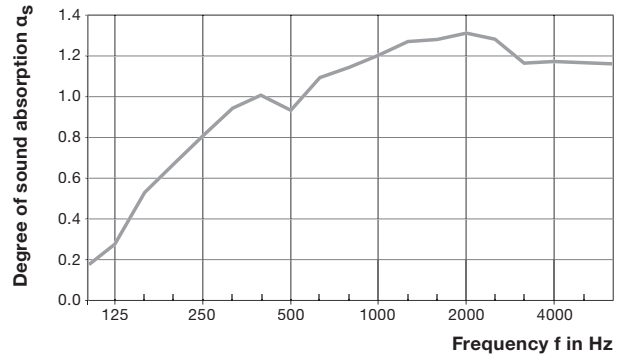

$\alpha_w = 1.00$

ZFP in perforated design with mineral wool shrink-wrapped in foil

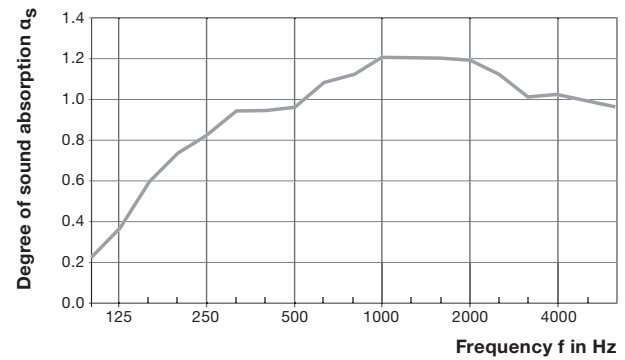

$\alpha_w = 1.00$

ZFP in smooth version with aluminium-laminated mineral wool

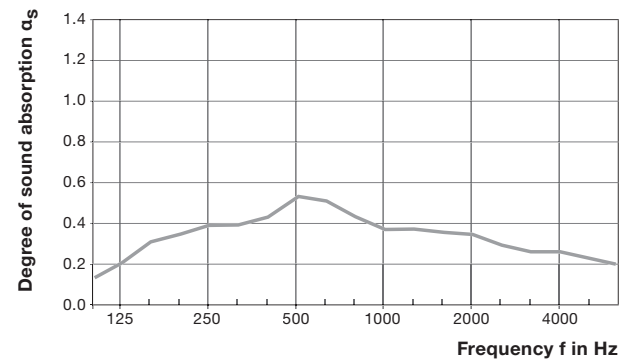

$\alpha_w = 0.40$

Standard fixing kits

There are twelve standard fixing kits for installing the radiant ceiling panels on the ceiling. In addition, Zehnder offers a number of customised solutions on request.

WOODEN CEILING

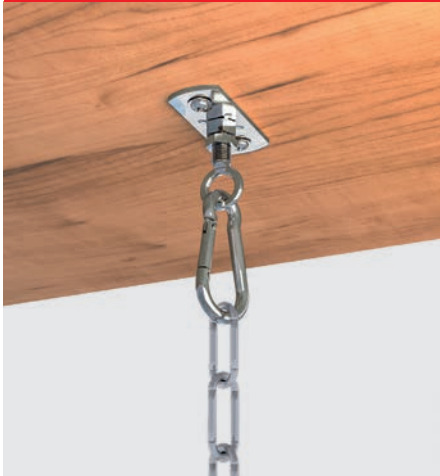

KN 52*

Minimum suspension height without link chain: 154 mm
Article number: 513520

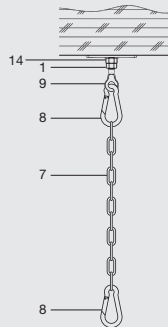

KN 82*

Minimum suspension height without link chain: 392 mm
Article number: 513530

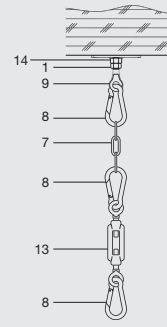

CONCRETE CEILING



KN 53

Minimum suspension height without link chain: 141 mm
Article number: 505160

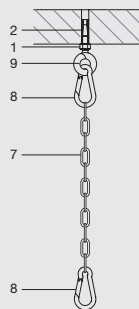

KN 83

Minimum suspension height without link chain: 379 mm
Article number: 505260

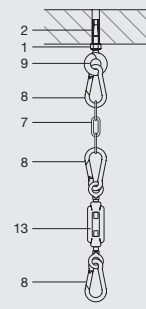

STEEL PROFILE



KN 54

Minimum suspension height without link chain: 141 mm
Article number: 505170

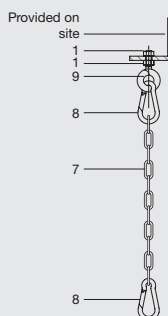

KN 84

Minimum suspension height without link chain: 379 mm
Article number: 505270

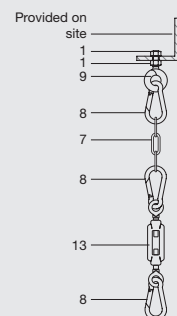

*Screws for ceiling mounting brackets must be purchased by the customer

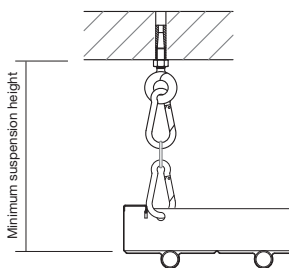

Key	Article number:
1 Hexagon nut M8	506080
2 Steel dowel M8	961120
3 Girder clamp M8	506030
4 Retaining cord	506100
5 Flat leaf screw M8	506050
6 Trapezoidal hanger M8	506020
7 Link chain 4 mm	509960
8 Carabiner hook 5 x 50	506010
9 Eyelet screw M8	506040
10 M8 washer	959020
11 M8 x 40 hexagon screw	506070
12 M8 x 110 hexagon screw	501500
13 Turnbuckle M6 x 110	506120
14 M8 support plate	513500

TRAPEZOIDAL SHEET METAL



KN 56
 Minimum suspension height
 without link chain: 183 mm
 Article number: 505210

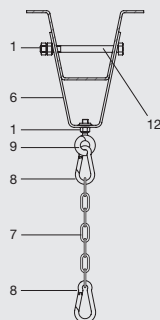

KN 86
 Minimum suspension height
 without link chain: 421 mm
 Article number: 505280

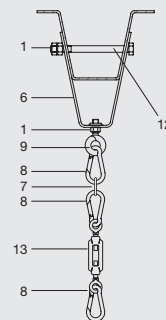

INCLINED STEEL GIRDER



KN 57
 Minimum suspension height
 without link chain: 172 mm
 Article number: 505220

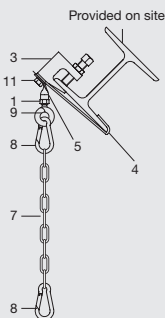

KN 87
 Minimum suspension height
 without link chain: 410 mm
 Article number: 505290

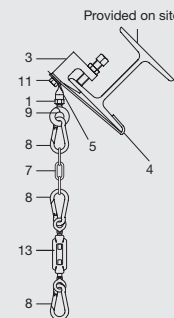

HORIZONTAL STEEL GIRDER



KN 58
 Minimum suspension height
 without link chain: 151 mm
 Article number: 505230

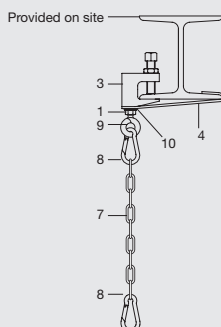

KN 88
 Minimum suspension height
 without link chain: 389 mm
 Article number: 505340

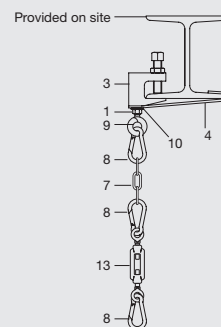

Suspension axes / Variable axes

Zehnder ZFP modules are always supplied with fixed suspension axes. These serve both as suspension axes for ceiling installation and as reinforcement for the module itself. All axes are provided with suspension holes and allow flexible adjustment of the suspension positions according to project requirements. The suspension distance is 3 m. The suspension axes enable an angled fitting of 45° across the length and 30° across the width.

The suspension distances can be adjusted during installation as required, using additional variable axes. The variable axes are installed on-site.

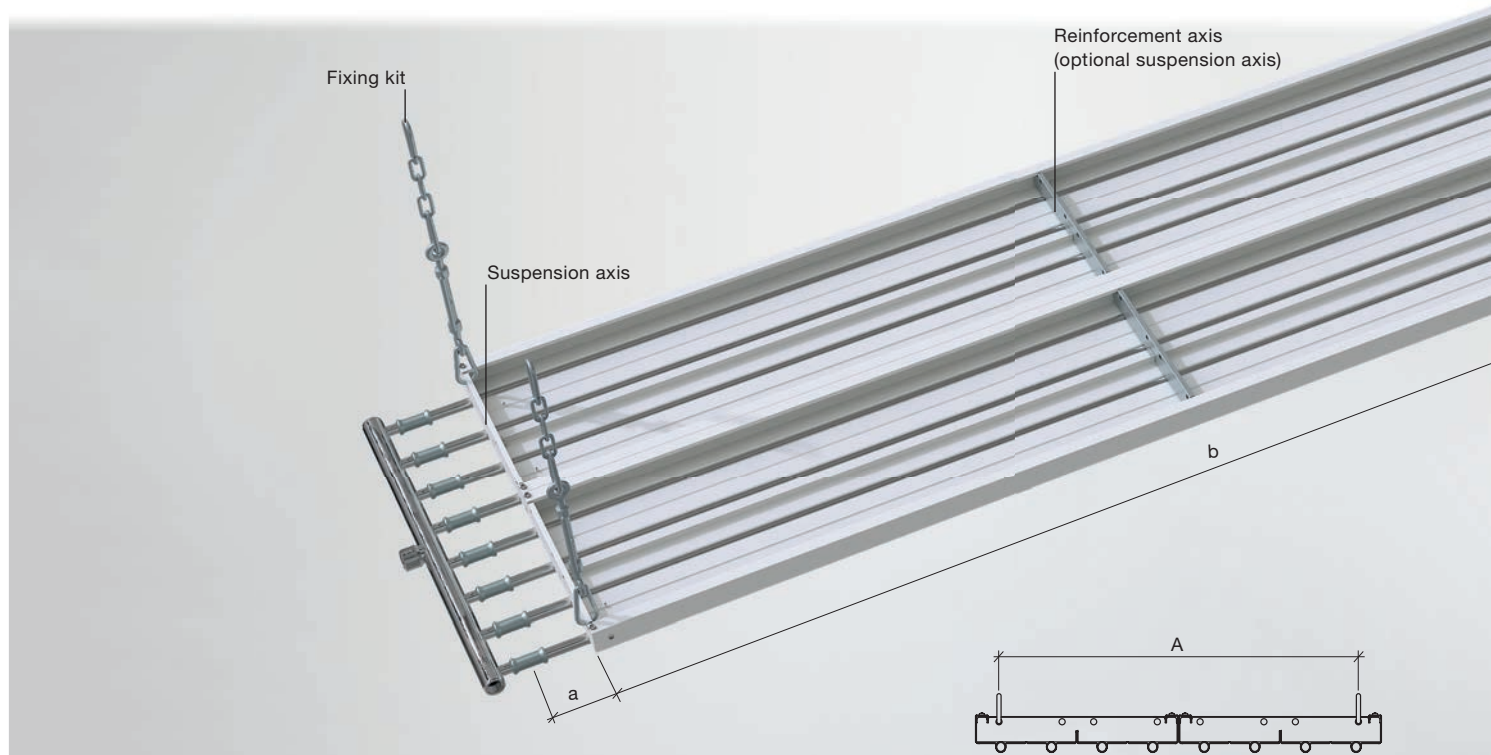

Article numbers			
Article number	Description	Model	A
514910	Variable axis ZFP 300/4	300/4	236
514920	Variable axis ZFP 450/6	450/6	386
514930	Variable axis ZFP 600/8	600/8	536
514940	Variable axis ZFP 750/10	750/10	686
514950	Variable axis ZFP 900/12	900/12	647
514960	Variable axis ZFP 1050/14	1050/14	703
514970	Variable axis ZFP 1200/16	1200/16	553
514980	Variable axis ZFP 1350/18	1350/18	703
514990	Variable axis ZFP 1500/20	1500/200	647

Recommended number of suspension axes per module	
Module length	Quantity
2,000 mm	2
3,000 mm	2
4,000 mm	2
5,000 mm	2
6,000 mm	2

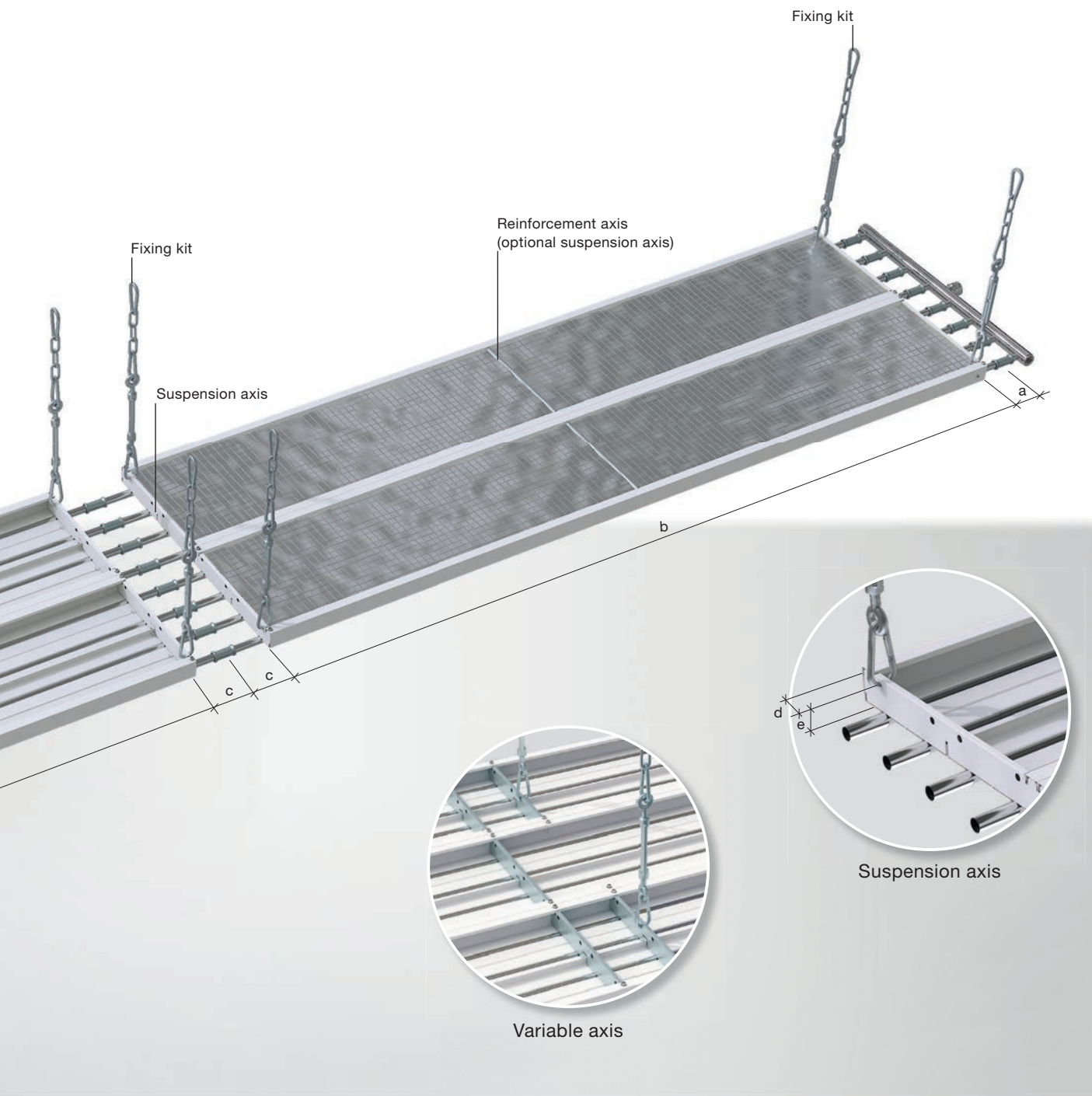

Dimensions

Item	Description	Dimension in mm	Min. dimension in mm	Max. dimension in mm
a	Header – first suspension axis	85	-	-
b	Suspension axis – suspension axis	Variable	1,000	3,000
c	Suspension axis – connection point	Variable	85	3,000
d	Outer edge of module – centre of 1st suspension point	Variable	32	428
e	Bottom edge of radiant plate – upper edge of suspension point	37	-	-

Minimum suspension heights with fixing kits – see specifications on page 38/39

Support tracks

The support tracks enable Zehnder ZFP modules to be installed as long strips close to the ceiling. The distance between the tracks can be up to 3 m. The support tracks' suspension distances do not necessarily have to correspond to the distances of the fixed axes. An angled fitting is not possible.

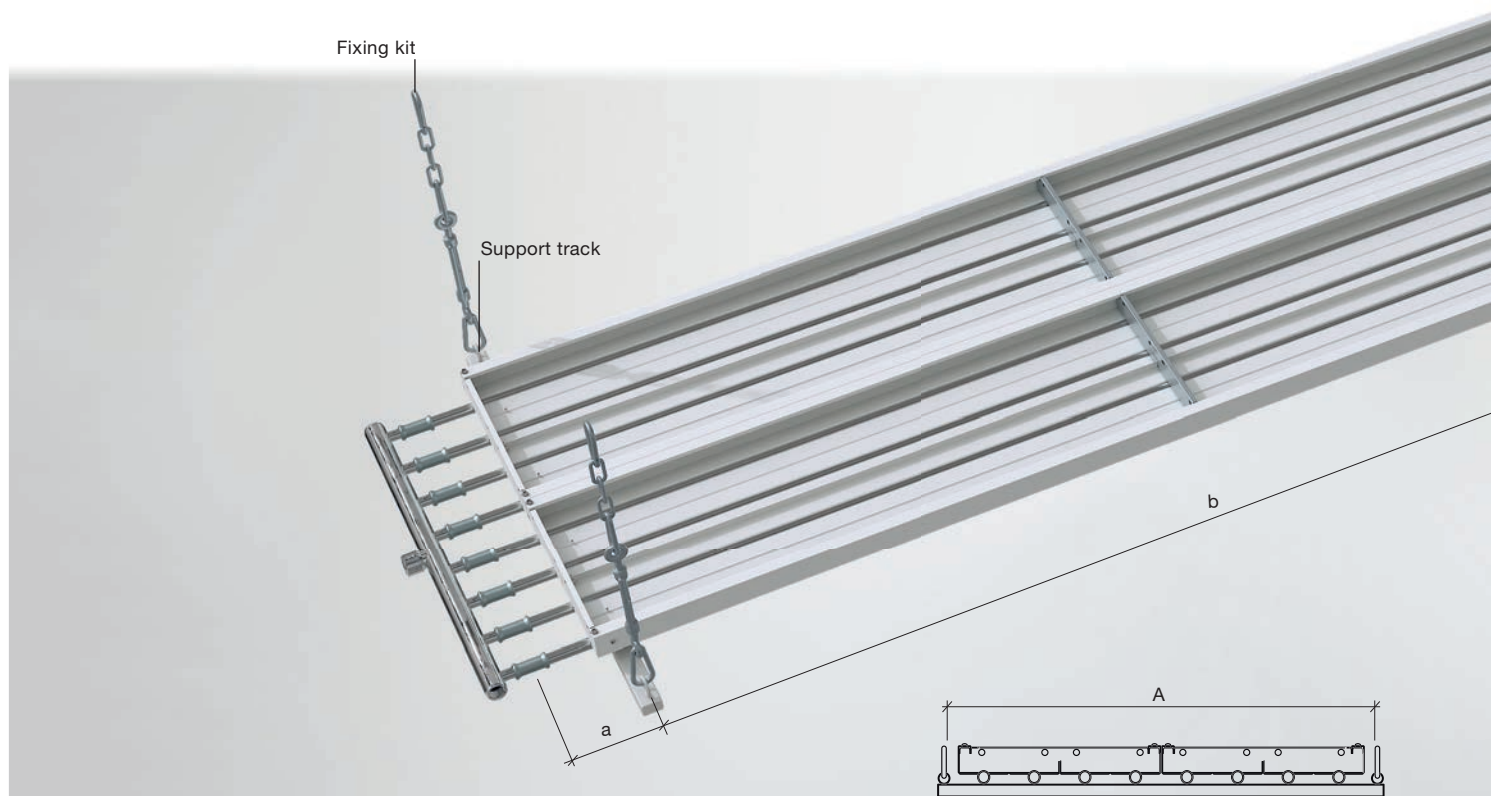

Article numbers			
Article number	Description	Model	A
515010	Support track 300/4	300/4	362 mm
515020	Support track 450/6	450/6	512 mm
515030	Support track 600/8	600/8	662 mm
515040	Support track 750/10	750/10	812 mm
515050	Support track 900/12	900/12	962 mm
515060	Support track 1050/14	1050/14	1112 mm
515070	Support track 1200/16	1200/16	1262 mm
515500	Support track 1350/18	1350/18	1412 mm
515600	Support track 1500/20	1500/20	1562 mm

Recommended number of support tracks per module	
Module length	Quantity
2,000 mm	2
3,000 mm	2
4,000 mm	2
5,000 mm	2
6,000 mm	2

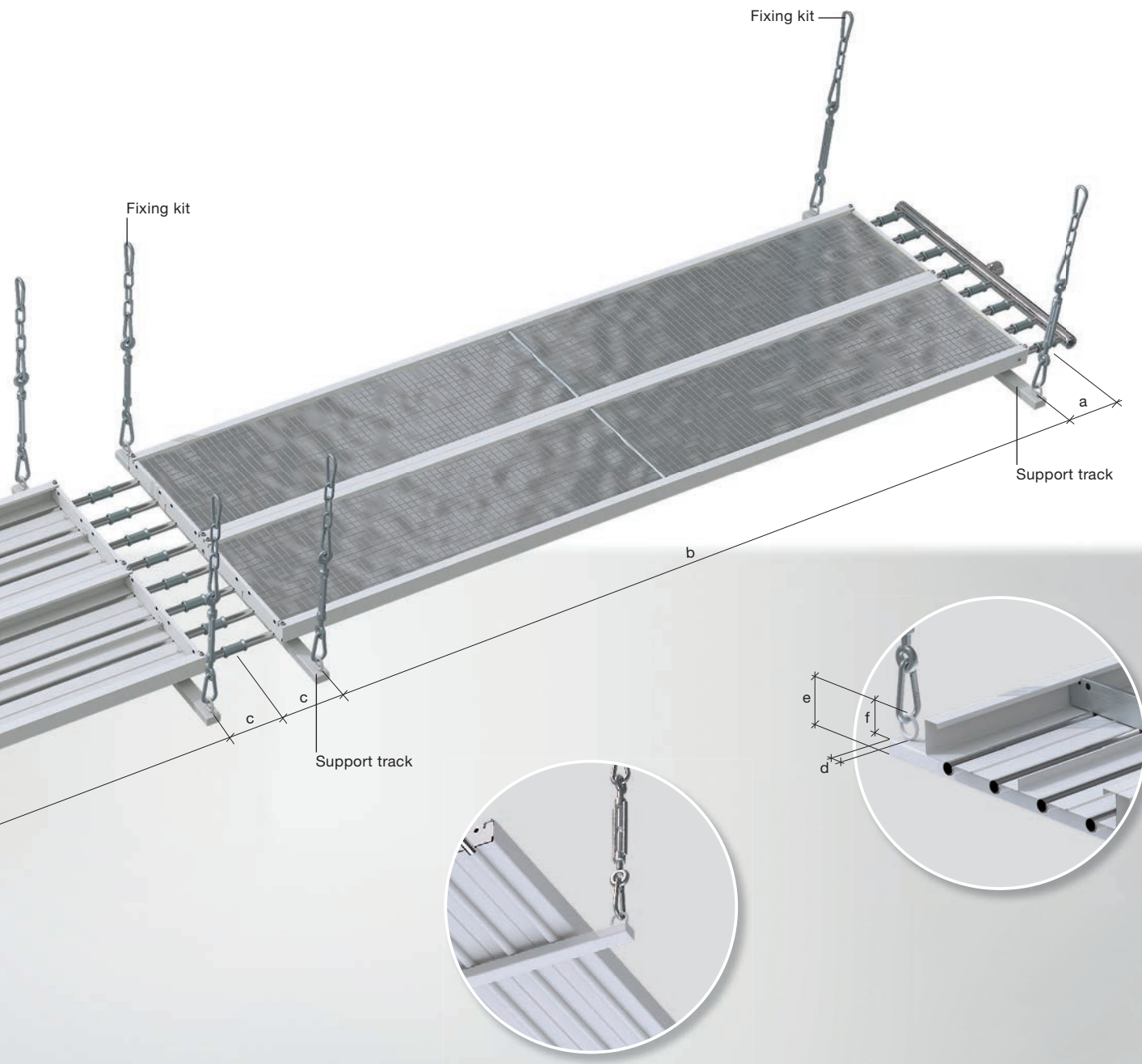

Dimensions				
Item	Description	Dimension in mm	Min. dimension in mm	Max. dimension in mm
a	Header – support track	Variable	85	915
b	Support track – support track	Variable	1,000	3,000
c	Support track – connection point	Variable	100	3,000
d	Outer edge of module – centre of suspension point	21	-	-
e	Bottom edge of support track – upper edge of suspension point	34	-	-
f	Bottom edge of radiant plate – upper edge of suspension point	14	-	-

Minimum suspension height			
Description	Dimension in mm	Description	Dimension in mm
KN52	146	KN82	384
KN53	133	KN83	371
KN54	133	KN84	371
KN56	175	KN86	413
KN57	164	KN87	402
KN58	143	KN88	381

Suspension technology with Z profiles

Zehnder ZFP modules can be fixed close to the ceiling using Z profiles. They also enable an angled fitting across the width of up to 45°. An angled fitting is not possible across the length.

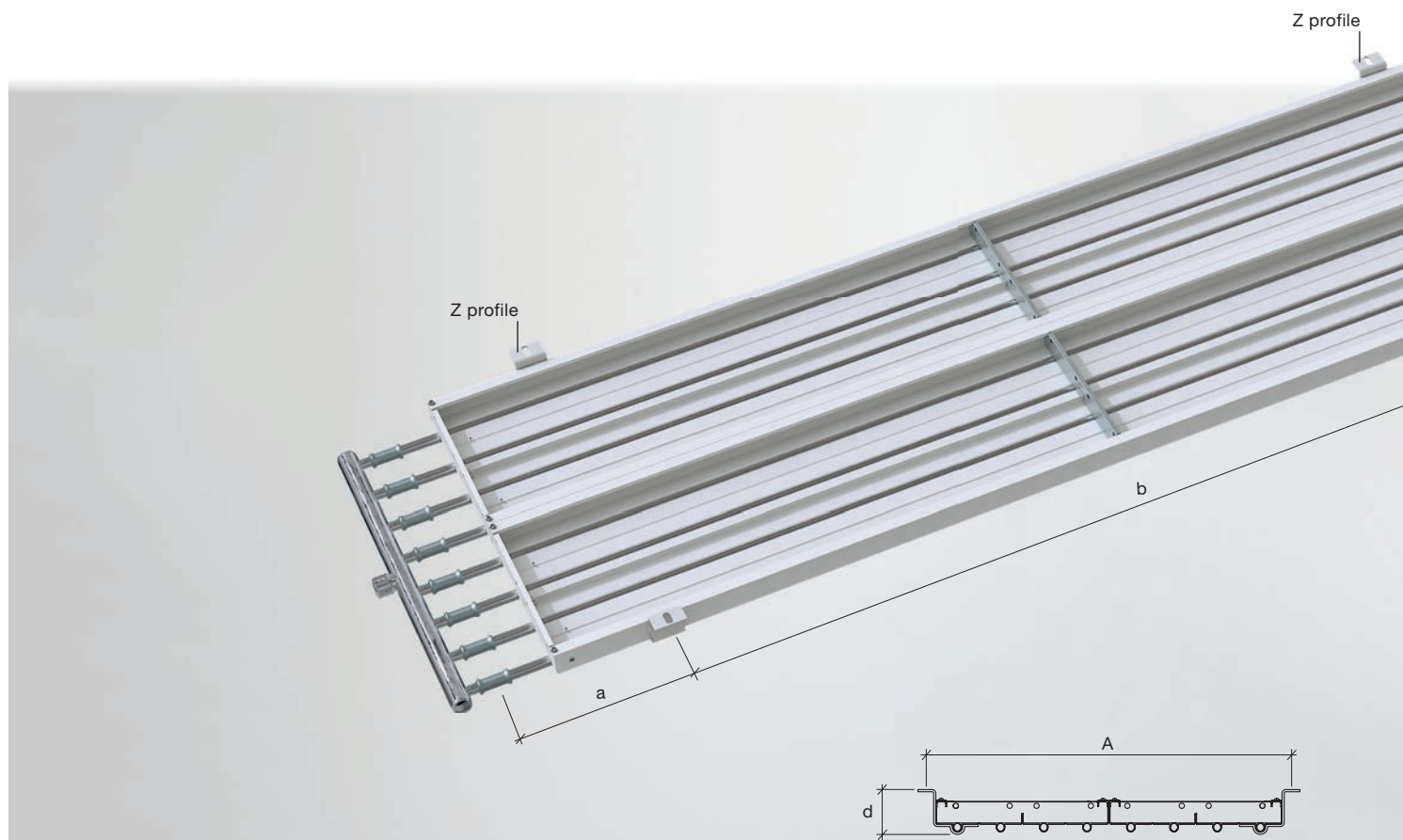

Article numbers			
Article number	Description	Model	A
516410	Z profile (pair)	300/4	345 mm
		450/6	495 mm
		600/8	645 mm
		750/10	795 mm
		900/12	945 mm
		1050/14	1,095 mm
		1200/16	1,245 mm

Recommended number of Z profiles (pairs) per module	
Module length	Quantity
2,000 mm	2
3,000 mm	2
4,000 mm	2
5,000 mm	2
6,000 mm	3

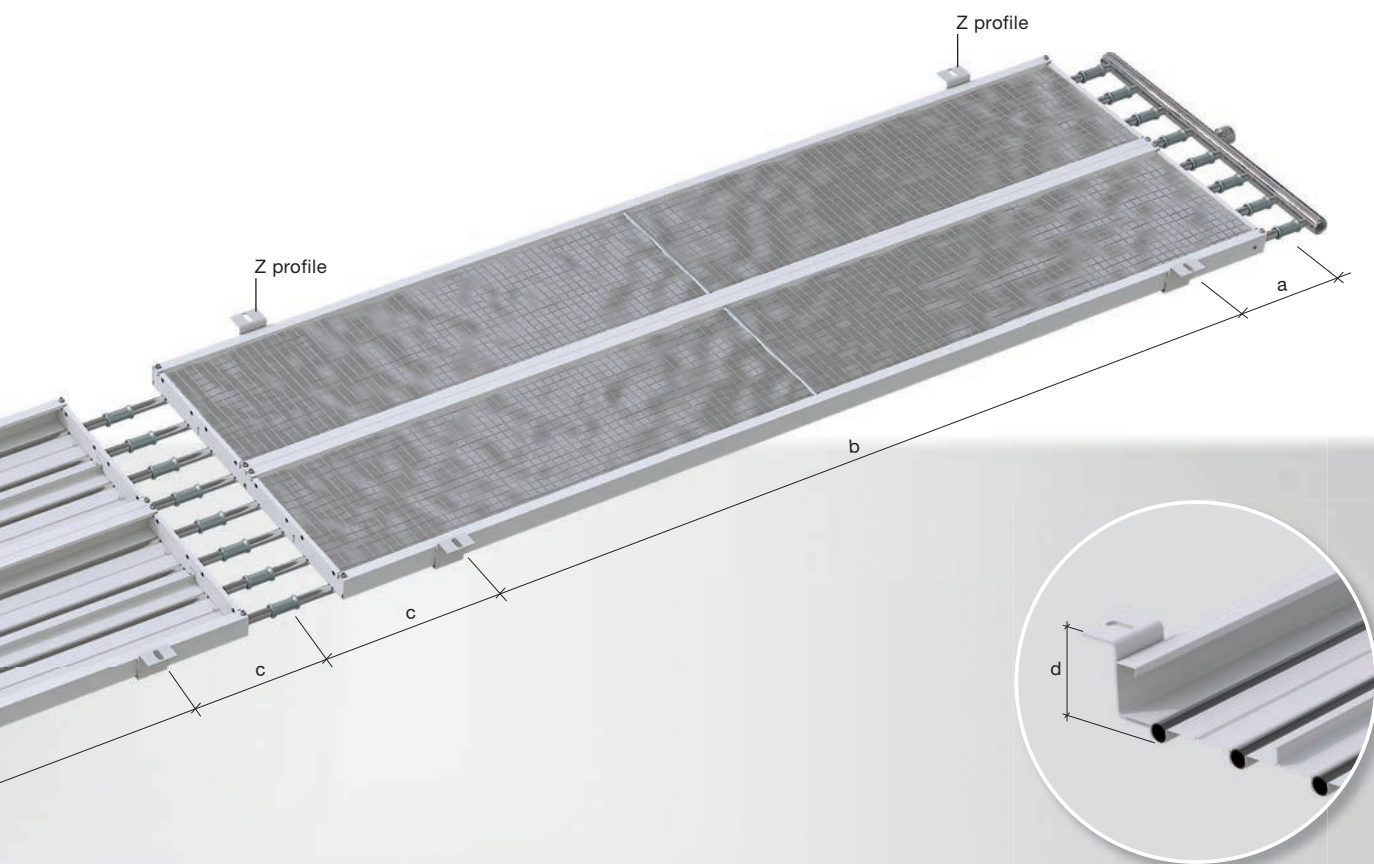

Dimensions

Item	Description	Dimension in mm	Min. dimension in mm	Max. dimension in mm
a	Header – Z profile	Variable	85	915
b	Z profile – Z profile	Variable	1,000	3,000
c	Z profile – connector piece	Variable	500	2,500
d	Bottom edge of Z profile – bottom edge of concrete ceiling	83	-	-

Individual project solutions

Zehnder ZFP radiant ceiling panels are extremely flexible: in addition to the wide standard range, there are also a number of special solutions available. Therefore, whatever the room and whatever the project, we have exactly what you need. Feel free to get in touch if you would like any advice.

BALL GUARDS/BALL IMPACT RESISTANCE

A practical solution for sports halls: the arched, galvanised grid prevents stray shots from getting caught in the radiant ceiling panels. Ball guards can be used with strips of Zehnder ZFP of any width.

Furthermore, Zehnder ZFP radiant ceiling panels have successfully passed testing for ball impact resistance to DIN 18032 by the Stuttgart Materials Testing Institute.



DUST PROTECTOR PANEL

Zehnder ZFP radiant ceiling panels can be sealed with a dust protector panel if required. An easy-care, hygienic solution that is ideal for rooms with high dust levels.



RAISED HEADERS

The headers finish above the radiant panel sheet and therefore cannot be seen from below.

This is the ideal solution for integrating Zehnder ZFP into a suspended ceiling.

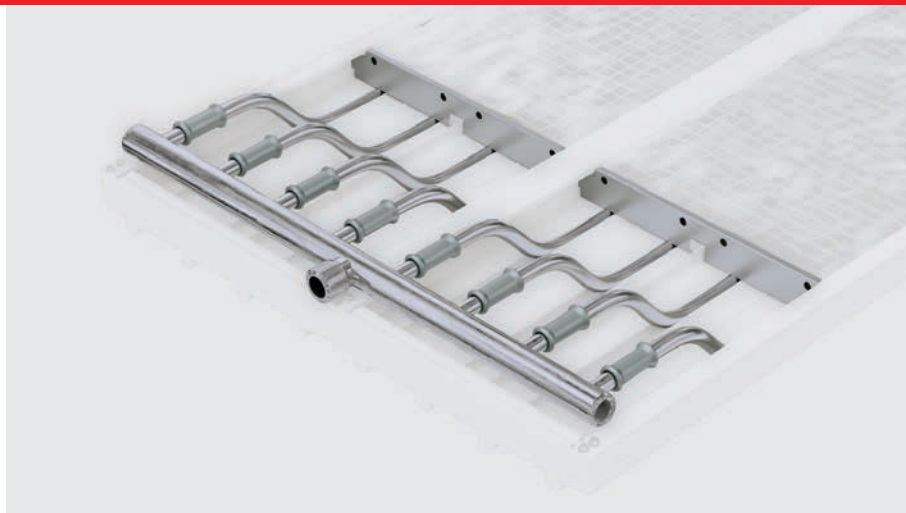

END COVER

End covers are offered as an option for Zehnder ZFP. These cover the points where the headers are connected to the modules. In combination with a header that is painted as well as galvanised, this creates a colour-coordinated appearance. All components that are visible from below are powder-coated with the same colour as the radiant ceiling panels.



NON-CONTINUOUS RADIANT PANEL PLATE

This version allows light to pass through unobstructed; for example, from skylights.

The length of the radiant plate interruption can be up to 3 m.

This special solution was designed by Zehnder's internal planning department.



The energy-efficient innovation

The modular Zehnder ZFP radiant ceiling panels have been designed to achieve maximum infrared thermal radiation to provide efficient climate control inside halls. Optional components such as the thermal radiation shield and innovative insulation concept significantly increase the proportion of radiation without dramatically reducing overall performance.

STRUCTURE AND THERMOGRAPHIC FLOW SIMULATION

The simulation shows a comparison and the proportion of convective thermal transfer of a Zehnder ZFP with and without a thermal radiation shield. The results reveal an increased level of thermal radiation in connection with the reduction in convective output. Overall performance remains virtually the same.

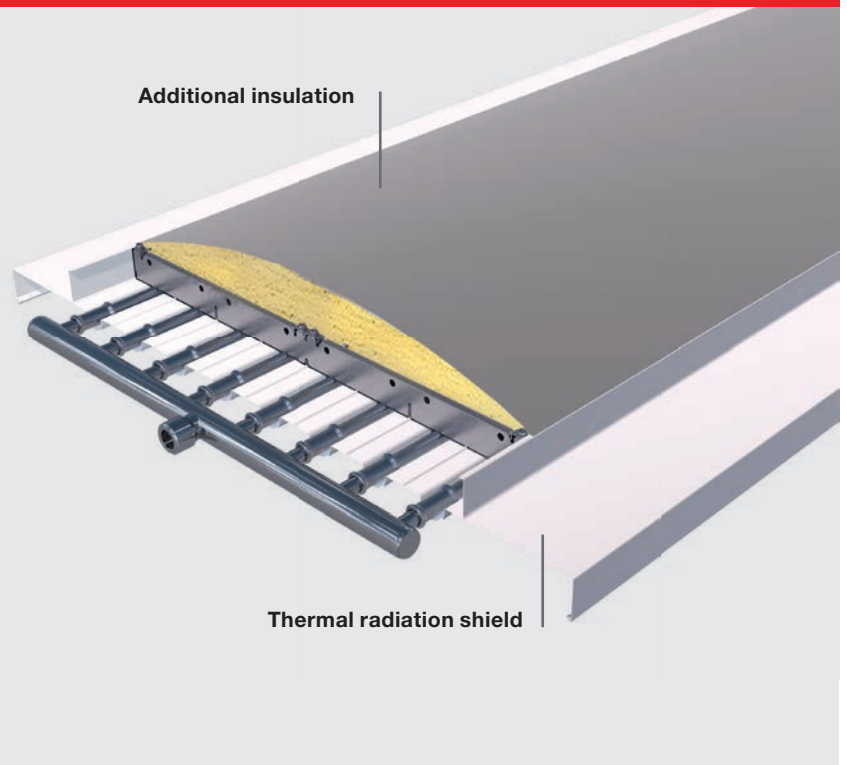
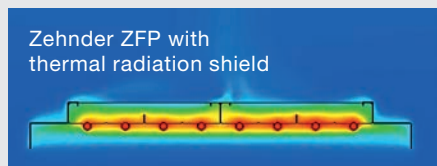
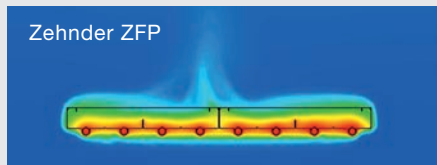

Proportion of radiation for Zehnder ZFP compared with conventional radiant ceiling panels

OPTIMISED THERMAL RADIATION: With conventional radiant ceiling panels, reducing the convective output also leads to a reduction in overall performance. With Zehnder ZFP by contrast, the proportion of infrared radiation increases without significantly compromising the convective proportion. As a result, overall performance remains at the same high level.

- Thermal radiation (W/m)
- Indirect useful output (W/m)
- Proportion of radiation (r)

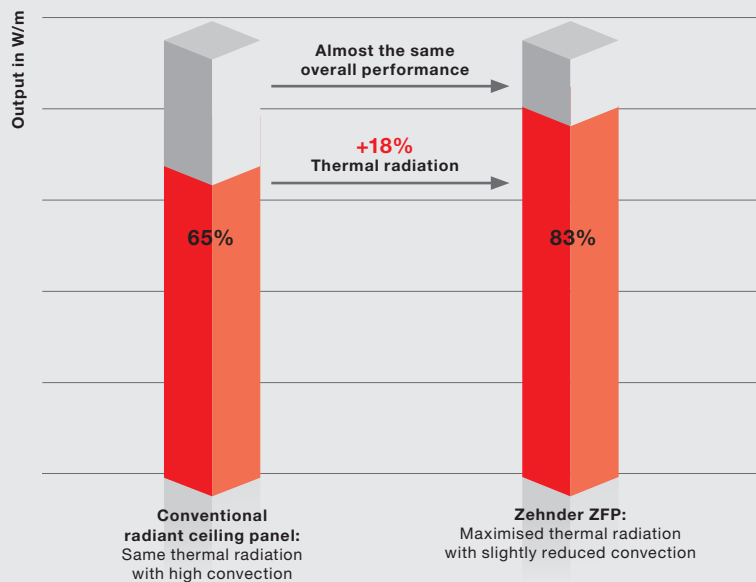

83%**Zehnder ZFP with thermal radiation shield**

The proportion of radiation increases to up to 83% when a thermal radiation shield is used.

89%**Zehnder ZFP with thermal radiation shield and insulation material**

A peak value of 89% is achieved by using a thermal radiation shield in combination with the innovative insulation concept.

5 REASONS FOR HIGH EFFICIENCY**HIGH ENERGY EFFICIENCY DURING HEATING AND COOLING**

Zehnder ZFP achieves the highest levels of thermal radiation when both heating and cooling. The effective and efficient transmission of the supplied energy reduces energy consumption.

LOW OPERATING COSTS AND EFFICIENT USE OF RESOURCES

Zehnder ZFP can be operated at low operating temperatures without compromising its high proportion of radiation. It can also be combined with modern heat pumps, resulting in further energy savings and low operating costs.

LOW INVESTMENT COSTS

Optimum overall performance with optimum thermal radiation. This results in lower investment costs, as fewer ceiling panels need to be installed to cover the heat load.

EASY AND QUICK TO RETROFIT

The thermal radiation shield and optional insulation concept can be retrofitted to increase Zehnder ZFP's thermal radiation to up to 89%. Coordinated components from the modular system mean that these elements can easily be retrofitted at any time.

CERTIFIED PROPORTION OF RADIATION

Zehnder ZFP achieves a proportion of radiation of up to 89% in measurements conducted in accordance with DIN EN 14037 and verified by an accredited test laboratory (HLK, Stuttgart). Test numbers: DC519 D12.5077; DC519 D12.5081

Overall performance of Zehnder ZFP compared with competitors**HIGH THERMAL RADIATION:**

Coordinated components help Zehnder ZFP radiant ceiling panels to achieve a proportion of radiation of up to 89% compared with competitors.

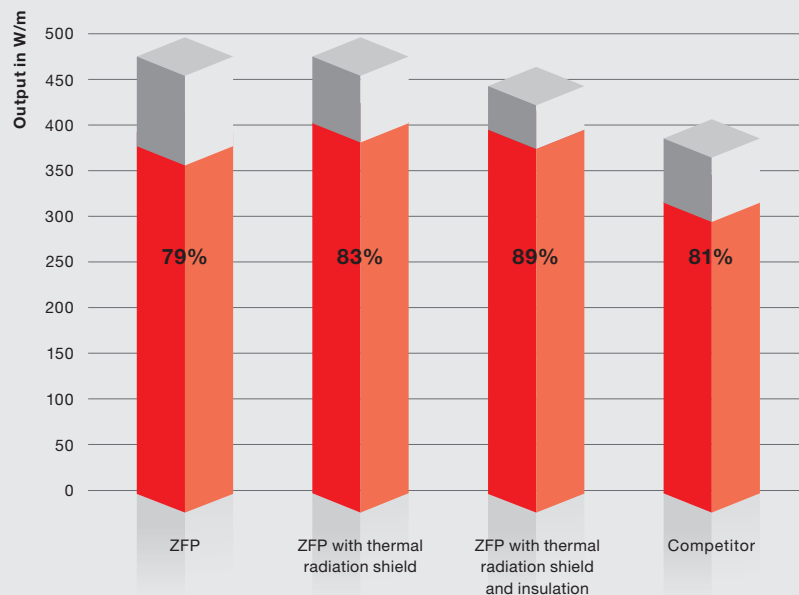

■ Thermal radiation (W/m)
■ Indirect useful output (W/m)

Controlled and cost-optimised heating and cooling

The control system technology for Zehnder radiant ceiling panels is a simple system, put together for small projects and simple applications. Components that are coordinated ex works guarantee easy installation. Support from Zehnder ensures your projects can be planned efficiently.

Detailed product information can be found in the planning document 'Reliable Planning' under the Downloads section at www.zehnder.co.uk

OUR SOLUTION

- **Reliable planning**
In-depth advice on products and planning support.
- **Simple installation**
Thanks to optimally coordinated components, simple and swift installation is ensured.
- **Intuitive operation**
Your desired temperature can easily be controlled using the control panel.
- **Sustainable and efficient**
Thanks to the constant room temperature, energy, maintenance and servicing costs are saved.

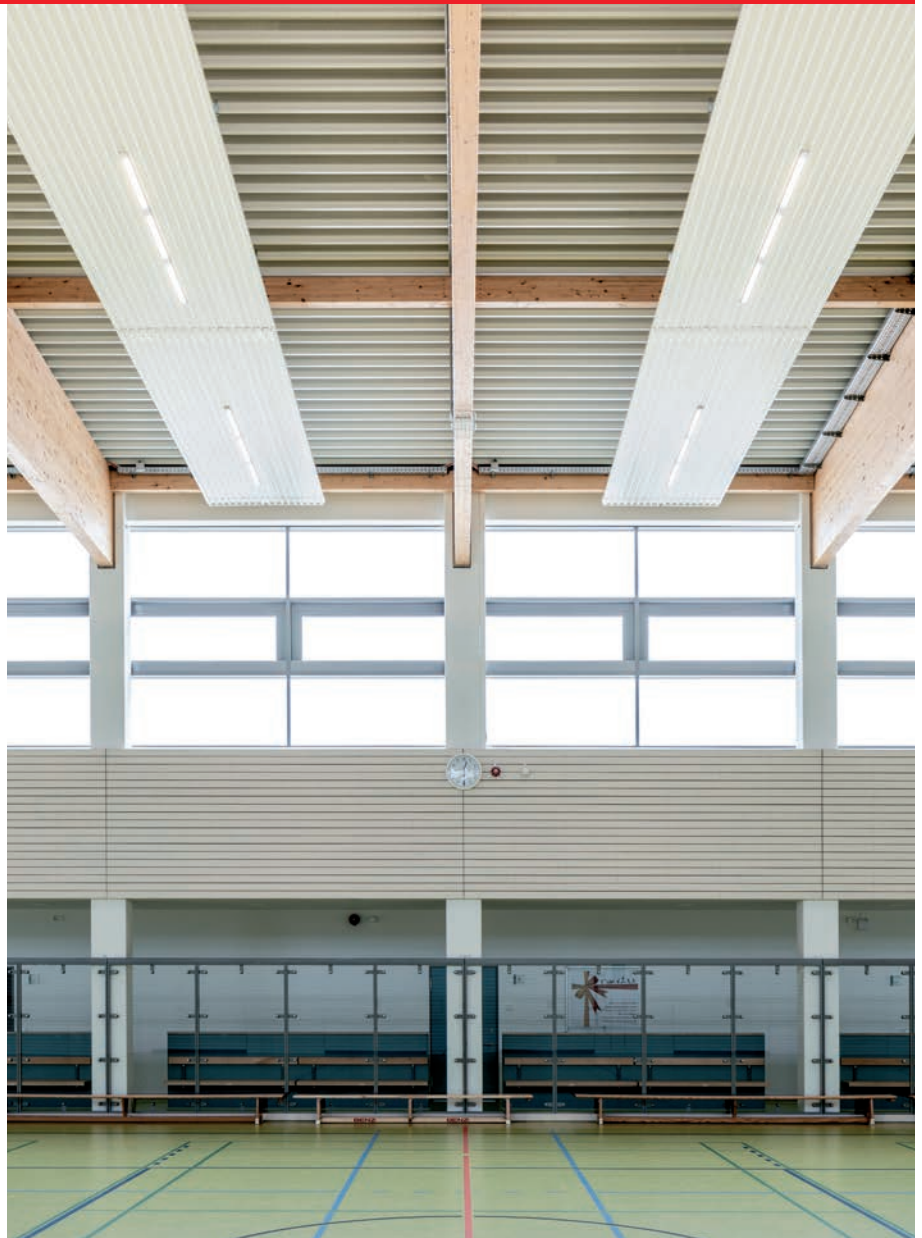

Zehnder LED 2.0 – Innovation meets aesthetics

Lighting and radiant ceiling panels share the ideal space on the ceiling – the perfect combination. Why? Both systems transmit energy in the form of radiation. The radiant ceiling panels from Zehnder use infrared radiation, while the new Zehnder LED 2.0 use light. Coordinated planning of light and heat is used as the basis for creating individual project solutions, ensuring the perfect application of both systems. Everything from a single source – from Zehnder.

You will find detailed product information in the planning document 'Efficient Illumination' under the Downloads section at www.zehnder.co.uk

OUR SOLUTION

- Innovative plug-and-play principle
- Individual project solutions
- Everything from a single source
- Modern lightweight design
- Safe application
- Easy to retrofit
- Complete aesthetic solution
- Efficient operation

Design example using LED 2.0
model Z 670



OUR SERVICE

- **Consulting**
 Technical consulting expertise
 Many years of practical experience
 On hand at all times
- **Planning**
 4 different light lengths
 3 different lens optics
 Plug-and-play principle
 Ball impact resistant as per
 DIN 18032
 All components tested according
 to EN 60598-1
- **Light calculation**
 Calculation report as a PDF
 Computational and graphical
 representation of the results
 List of materials
 Tender specifications

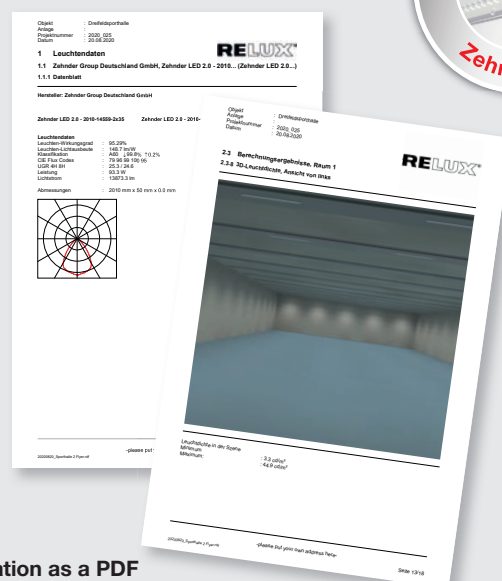

Your lighting calculation as a PDF
 We create individual lighting calculations, including all
 of the necessary project data.

Dimensions, operating parameters and output

Feature	Unit of measurement	300/4	450/6	600/8	750/10	900/12	1050/14	1200/16	1350/18	1500/20
Number of tubes	Piece(s)	4	6	8	10	12	14	16	18	20
Tube material	–	Precision steel tube 15 x 1 mm, welded, external galvanisation in line with EN 10305-3								
Radiant plate	–	Fully galvanised, coated sheet steel								

Dimensions

Widths	mm	300	450	600	750	900	1,050	1,200	1,350	1,500
Tube spacing	mm	75								
Minimum module length	mm	2,000								
Maximum module length	mm	6,000								
Suspension points per axis	Piece(s)	2								
Transverse distance between suspension points (A) ¹⁾	mm	236	386	536	686	647	703	553	703	647

Operating parameters ²⁾

Max. operating temperature	°C	120 ³⁾ / 95 ⁴⁾								
Max. operating pressure	bar	12 ³⁾ / 5 ⁴⁾								

Weight ⁵⁾

Weight without water content, with insulation	Radiant panel	kg/m	3.9	5.4	7.6	9.2	10.7	13.0	14.6	16.1	18.4
	Per manifold	kg	0.7	0.9	1.2	1.5	1.7	2.0	2.3	2.5	2.8
Insulation weight		kg/m	0.2	0.3	0.5	0.6	0.7	0.8	0.9	1.0	1.2
Water content		l/m	0.5	0.8	1.0	1.3	1.6	1.9	2.1	2.4	2.6
Operating weight with water content, with insulation	Radiant panel	kg/m	4.4	6.2	8.6	10.5	12.3	14.9	16.7	18.5	21.0
	Per manifold	kg	0.8	1.2	1.6	1.9	2.3	2.7	3.0	3.4	3.8
Weight of ball guards		kg/m	0.3	0.4	0.6	0.7	0.8	0.9	1.7	2.9	3.2
Weight of dust protector panel		kg/m	1.0	1.6	2.0	2.6	3.1	3.6	4.1	4.7	5.2

Dimensions, operating parameters and output

Feature	Unit of measurement	300/4	450/6	600/8	750/10	900/12	1050/14	1200/16	1350/18	1500/20
Thermal output										
Thermal output according to EN 14037-3 at $\Delta T = 55$ K with insulation	W/m	202	283	364	438	512	586	660	736	813
Thermal output constant (K)	–	1.695	2.420	3.170	3.839	4.517	5.204	5.899	6.732	7.600
Thermal output exponent (n)	–	1.193	1.188	1.184	1.182	1.181	1.179	1.177	1.172	1.166

Cooling capacity with thermal insulation

Cooling capacity according to EN 14037-4 at $\Delta t = 8.5$ K with insulation	W/m	29	42	55	67	79	91	103	116	129
Cooling capacity constant (K)	–	2.752	4.000	5.247	6.383	7.518	8.653	9.789	11.006	12.224
Cooling capacity exponent (n)	–	1.100	1.100	1.100	1.100	1.100	1.100	1.100	1.100	1.100

Cooling capacity without thermal insulation

Cooling capacity according to EN 14037-4 at $\Delta t = 8.5$ K without insulation	W/m	35	51	66	81	95	109	124	139	154
Cooling capacity constant (K)	–	3.302	4.800	6.296	7.660	9.022	10.384	11.747	13.207	14.696
Cooling capacity exponent (n)	–	1.100	1.100	1.100	1.100	1.100	1.100	1.100	1.100	1.100

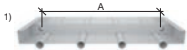

When installing on suspension axes

²⁾ Water quality in accordance with VDI 2035

³⁾ Crimp connection

⁴⁾ Threaded connection

⁵⁾ The actual load on the supporting structure must be determined during the planning phase. The horizontal and vertical forces created by the installation conditions on site must be taken into account.

Tender specifications

Zehnder ZFP radiant ceiling panel according to DIN EN 14037, all metallic components must be fully galvanised at the factory.

Zehnder ZFP radiant ceiling panel consists of a galvanised steel sheet with a max. thickness of 0.45 mm with special clip profiling to accommodate externally galvanised precision steel tubes with an external diameter of 15 mm to DIN EN 10305-3, suspension axes and an upper insulation. Mineral wool thermal insulation installed at the factory according to EU Directive 97/69 (note Q), lined with 40 mm thick aluminium grille on one side. The lambda value of the mineral wool is 0.038 W/mK. The radiant ceiling panel is optimally statically reinforced using fibres, special duplications, clinched joints and edgings. It must therefore be possible to realise centre distances of 3 m. The operating weight of the radiant ceiling panel in the standard version must not exceed 15 kg/m². This means that the Zehnder ZFP is suitable for generating low roof loads and enabling the subsequent installation of additional loads on the roof.

An operating temperature of max. 120 °C is possible, the operating pressure is max. 12 bar. The manifolds are made of externally galvanised round pipe with an outer diameter of 30 mm and connectors with an external thread of R1" according to DIN EN 10266. The headers (connection manifolds) have a blind cover and a sleeve, each in ½ inch, for venting and draining.

The radiant ceiling panel is supplied in modules and separate manifolds (headers and collectors). Both modules and manifolds are connected on site by means of galvanised press-slide sleeves or galvanised screw connections. All metallic components are fully galvanised. It has a protective lacquer on the back and a polyester coating on the visible side. Corrosion resistance proven in accordance with DIN EN ISO 6270-2. Full galvanisation must be ensured so that a cooling option can be realised with the radiant ceiling panel.

Depending on the version, the radiant ceiling panel is characterised by a proportion of radiation of up to 89%. It must also be possible to increase the thermal radiation and the proportion of radiation subsequently. The proportion of radiation must be verified by an accredited test laboratory. For structural reasons, flat radiant panel systems without pipe beading or pipes that are arranged over the radiant ceiling are not permitted. Uneven radiant plates which deviate from the horizontal plane are excluded. In order to ensure optimum heat distribution within the panel, as well as a resulting higher output, a minimum of 13 m of pipe per m² of radiant panel must be installed. In order to ensure turbulent flow and thus optimum heat transfer even with short panel lengths, the internal pipe diameter must not exceed 13 mm. For optical reasons, only pipes with a max. external diameter of 15 mm are permitted. For the radiant ceiling panel, it must be possible to retrofit lighting at any point along the length (except for cover plates). For optical reasons, the position of the lamps must always be possible in the centre of the panel across the width. Panels with an odd number of pipes are therefore not permitted. The radiant ceiling panel must be tested for ball impact resistance in accordance with DIN 18032.

Radiant ceiling panels made of aluminium are not permitted due to possible deformations caused by mechanical effects. All components must comply with building material class A1 in accordance with EN 13501-1. An exception applies only to insulation materials which must be shrink-wrapped in LDPE film for hygiene reasons. The radiant panel must be operated with water in accordance with VDI 2035. They are available in either a smooth or perforated design. For perforated radiant ceiling panels, an alpha-w value of at least 1.0 must be achieved.

Planned product: Zehnder radiant ceiling panel type ZFP

Thermal insulation

Aluminium-laminated mineral wool

Mineral wool exempt according to EU Directive 97/69 (note Q); lined with aluminium grille on one side
λ = 0.038 W/mK, thickness 40 mm

Mineral wool shrink-wrapped in foil

Mineral wool exempt according to EU Directive 97/69 (note Q), lined with black fleece and shrink-wrapped in LDPE foil
λ = 0.040 W/mK, thickness 40 mm

Acoustic insulation

Mineral wool, coated with glass mat on both sides (natural/black)
λ = 0.035 W/mK, thickness 40 mm

Operating parameters

Heating medium /°C
Room temperature /°C
Operating pressure bar
Thermal output (overall) W
Module length (overall) m

Crimp connection (article no. 502280)

Galvanised crimp connection 15 mm Piece(s)

Threaded connection (article no. 633010)

Galvanised clamping ring screw connection 15 mm Piece(s)

Cover plates

Made of 0.45 mm thick sheet steel, galvanised on both sides, coated externally with polyester paint similar to RAL 9016, used to cover the crimp or threaded connections at the connection points and on the headers

Upper covers

Dust protector panel

Galvanised upper plate cover (thickness 0.63 mm) incl. fixing clamps and screws – delivered loose

Ball guards

Galvanised metal grill cover incl. fixing clips and screws for use in sports facilities – delivered loose

Fastening system

Fixing kit KN 52 (article no.: 513520)
for fixing to wooden ceilings piece(s)

Fixing kit KN 53 (article no.: 505160)
for fixing to concrete ceilings piece(s)

Fixing kit KN 54 (article no. 505170)
for fixing to steel profile piece(s)

Fixing kit KN 56 (article no. 505210)
for fixing to trapezoidal sheet metal piece(s)

Fixing kit KN 57 (article no. 505220)
for fixing to inclined steel girders piece(s)

Fixing kit KN 58 (article no. 505230)
for fixing to horizontal steel girders piece(s)

Fixing kit KN 82 (article no. 513530)
for fixing to wooden ceilings piece(s)

Fixing kit KN 83 (article no. 505260)
for fixing to concrete ceilings piece(s)

Fixing kit KN 84 (article no. 505270)
for fixing to steel profile piece(s)

Fixing kit KN 86 (article no. 505280)
for fixing to trapezoidal sheet metal piece(s)

Fixing kit KN 87 (article no. 505290)
for fixing to inclined steel girders piece(s)

Fixing kit KN 88 (article no. 505340)
for fixing to horizontal steel girders piece(s)

Volume flow controller

VSRK-15 (article no.: 513810)
Zehnder VSRK-15 (150–700 l/h) volume flow control combination consisting of a volume flow controller and a ball valve. The volume flow controller is a valve combination which consists of an automatic flow rate controller (with a factory-set nominal value) and an actuator head. The actuator head can be equipped with an actuator (threaded connection M30 x 1.5). The volume flow controller is used for hydraulic balancing of radiant ceiling panels.

Technical specifications:

Dimensions: DN15
Max. operating temperature ts: 120 °C
Min. operating temperature ts: -10 °C
Max. operating pressure ps: 16 bar (1,600 kPa)
Max. differential pressure: 4 bar (400 kPa)

Medium: Water or ethylene/propylene glycol water mix (max. 50%), pH value 6.5–10
Housing made of dezincification-resistant brass, seals made of EPDM or PTFE, valve spindle made of stainless steel.

Article numbers:

VSRK-15 combination, 30–210 kg/h	513800
VSRK-15 combination, 150–700 kg/h	513810
VSRK-25 combination, 300–2,000 kg/h	513820
VSRK-32 combination, 600–3,600 kg/h	513830
VSRK Special 15/15/15, 30–210 kg/h	513840
VSRK Special 15/15/15, 150–700 kg/h	513850
VSRK Special 25/15/15, 300–2,000 kg/h	513860
VSRK Special 25/25/25, 300–2,000 kg/h	513870
VSRK Special 32/25/25, 600–3,600 kg/h	513880
VSRK Special 32/32/32, 600–3,600 kg/h	513890
Controller, separate DN15, 30–210 kg/h	513900
Controller, separate DN15, 150–700 kg/h	513910
Controller, separate DN25, 300–2,000 kg/h	513920
Controller, separate DN32, 600–3,600 kg/h	513930
Flow, separate DN15	513940
Flow, separate DN25	513950
Flow, separate DN32	513960

Armoured hose

Zehnder armoured hose for heating systems, consisting of temperature-resistant and age-resistant EPDM with stainless-steel braided sleeve.

DN15 hose (article no.: 513430)

Inner installation dimension: 500 mm
Hose length: 540 mm
Permissible operating pressure: 12 bar
Operating temperature range: 90 °C
Connections: External thread R ½"
Coupler Rp ¾"

Article numbers:

Armoured hose DN15	509260 / 513430
Armoured hose DN25	509280 / 513440
Armoured hose DN32	509310 / 513450
Reducing sleeve 1" x ½"	501170
Sleeve 1"	501190
Reducing sleeve ¾" x 1"	501180
Coupler screw connection ¾" x ½"	514000

ALWAYS THE BEST CLIMATE

“We strive to improve the quality of life by providing the finest indoor climate solutions.”



Excellent team

Every day we combine passion, expert knowledge and commitment to give you the best results.



Great solutions, products and services

Great products and unique service for an energy-efficient, healthy and comfortable indoor climate.

WE ARE THE SPECIALISTS FOR A HEALTHY, COMFORTABLE AND ENERGY-EFFICIENT

The broad and clearly structured portfolio from the Zehnder Group is split into five product lines. Consequently, we can provide our customers with the right product, perfect system and matching service for all types of projects – from new build to renovations, single or multi-occupancy homes, as well as commercial projects. This variety ensures that our wealth of experience is continuously expanding, providing tangible added value to our customers on a daily basis.



Comfortable indoor ventilation

Our comfortable indoor ventilation is energy-efficient and provides a healthy indoor climate. It promotes the wellbeing of the occupants and increases the value of the property.

OUR BRAND REPRESENTS INNOVATION, QUALITY AND DESIGN



The Zehnder brand offers excellent indoor climate solutions within the product lines of decorative radiators, comfortable indoor ventilation, climate ceiling solutions and clean air solutions.

INNOVATION OVER 5 GENERATIONS



First choice for customers

Always close to the needs of our customers, to grow with you and overcome all challenges together.

MANUFACTURER OF THE WORLD'S

1st

STEEL AND BATHROOM RADIATORS

REPRESENTED IN MORE THAN

70 COUNTRIES

AROUND **3,500** EMPLOYEES

17 OF OUR OWN PRODUCTION PLANTS IN EUROPE, NORTH AMERICA AND CHINA

INNOVATION SINCE **1895**

AROUND **40,000**

TRAINED CUSTOMERS PER YEAR

900 PATENTS AND DESIGN RIGHTS THROUGHOUT THE WORLD

INDOOR CLIMATE



Decorative radiators

Our individual decorative radiators make every room – whether at home or in commercial or public buildings – not only warmer, but also more attractive. They combine iconic design with outstanding comfort experience.



Climate ceiling solutions

The ceiling is the perfect place to supply a room with convenient heating and cooling. Energy-efficient climate via radiant panels work perfectly with our suite of solutions from office to manufacturing spaces.



Clean air solutions

Air cleaning systems from Zehnder effectively reduce the amount of dust and other particles in the air. The result: clean working environments, significantly improved employee health and enhanced business performance.

BEST QUALITY CERTIFICATES

Zehnder Group products are frequently awarded prizes for design and innovative technology.

