

# Zehnder ComfoAir 70

Operating and installation instructions for user and installer



## **Legal regulations**

All rights reserved.

This manual has been compiled with the utmost care. Nevertheless, the publisher accepts no liability for damage caused by missing or incorrect details in this manual. We reserve the right at any time and without previous notification to change the content of these instructions in part or as a whole.

The information contained in these documents is the property of Zehnder Group. Publication, as a whole or in parts, requires the written approval of Zehnder Group. In-house duplication, designated for the evaluation of the product or for proper use, is permitted and not subject to approval.

## **Zehnder manufacturer's warranty**

The current warranty terms can be obtained in paper form using the normal distribution channels.

## **Trademarks**

All trademarks are recognized, even if they are not separately labelled. A missing label does not mean that an article or sign is free of trademark rights.

© 2017 Zehnder Group

## Contents

<b>0</b>	<b>Preface .....</b>	<b>5</b>
0.1	Validity.....	5
0.2	Target group and standard operation .....	5
0.2.1	Qualification of target group .....	5
0.2.1.1	Users .....	5
0.2.1.2	Qualified personnel .....	5
0.2.2	Standard operation of the unit.....	5
<b>1</b>	<b>Introduction and safety .....</b>	<b>5</b>
1.1	Proper use.....	5
1.1.1	ComfoAir 70 ventilation unit .....	5
1.1.2	Control panels .....	5
1.2	Safety .....	6
1.2.1	Safety regulations .....	6
1.2.2	Installation conditions .....	6
1.2.3	Symbols used.....	6
1.3	Warranty and liability.....	6
1.3.1	Warranty provisions .....	6
1.3.2	Liability .....	7
<b>2</b>	<b>Instructions for the user and qualified personnel .....</b>	<b>7</b>
2.1	Product description .....	7
2.1.1	Type label.....	8
2.1.2	Frost protection .....	8
2.1.2.1	Frost protection mode .....	9
2.1.3	Joint operation with fireplaces.....	9
2.2	Functionality of the internal and external control panel .....	9
2.3	Operating functions and signalling from the control panel.....	10
2.3.1	Automatic operating mode .....	12
2.3.1.1	Functional principle of HUMIDITY sensor.....	13
2.3.1.2	Functional principle of CO <sub>2</sub> / VOC sensor.....	13
2.4	Maintenance by the user.....	13
2.4.1	Replacing the unit filters.....	14
2.4.2	Resetting the filter runtime .....	15
2.4.3	What should I do in case of a malfunction? .....	15
2.5	Disposal.....	16
<b>3</b>	<b>Instructions for the qualified personnel .....</b>	<b>16</b>
3.1	Installation requirements .....	16
3.1.1	Transport and packaging .....	16
3.1.2	Checking the scope of delivery .....	16
3.2	Installation .....	16
3.2.1	General installation instructions .....	16
3.2.2	Installation preparations .....	17
3.2.3	Connecting the ventilation tubes (only for adjoining room connection) .....	17
3.2.4	Installing the ventilation unit .....	19
3.2.5	Electrical connections .....	22
3.2.5.1	Connection for power supply.....	22
3.2.5.2	Connecting the external control panel .....	24
3.2.5.2.1	Connecting the cable for the external control panel on the ventilation unit .....	24
3.2.5.2.2	Connecting the cable on the external control panel.....	25
3.2.5.3	Connecting the internal control panel .....	26
3.2.5.4	Installing and connecting the sensor module.....	26

3.2.6	Parameterizable operating modes .....	28
3.2.6.1	Configuration of Automatic operating mode.....	28
3.2.6.2	Configuration of the boost ventilation mode.....	28
3.2.6.3	Configuration of the Away mode .....	28
3.2.7	Installing the exterior wall panel.....	28
3.3	Maintenance and repair by the qualified personnel .....	30
3.3.1	Inspection and cleaning of enthalpy exchanger.....	30
3.3.2	Replacing the fans .....	32
3.3.3	Exchanging the control board .....	32
3.4	Visualization of fault notifications .....	33
3.4.1	Fault codes in the Fault status .....	33
3.5	Technical description .....	33
3.5.1	Pressure loss-Volume flow-Characteristic curves for design of adjoining room connection .	34
3.5.2	Dimensions .....	35
3.5.3	Mounting template (figure not true to scale) .....	36
3.5.4	Terminal scheme.....	37
<b>4</b>	<b>Appendices .....</b>	<b>38</b>
4.1	Checklist A Maintenance work for users.....	38
4.2	Checklist B Maintenance work for qualified personnel .....	39
4.3	Commissioning and handover protocol.....	40
4.4	Air volume protocol .....	41
4.5	Product data sheet .....	42
4.6	Product label .....	44
4.7	Conformity .....	45
4.7.1	Declaration of conformity of the European Union .....	45
4.7.2	EAC certificate of the Eurasian Economic Union.....	46

## 0 Preface

### 0.1 Validity

This document applies to:

- Unit type ComfoAir 70 series

The unit type series are hereinafter designated with the common product name, ComfoAir 70.

The subject of this manual is the ComfoAir 70 in its various design variants. Possible accessories are only described to the extent necessary for appropriate operation of the unit. Please refer to the respective instructions for further information on accessory parts.

### 0.2 Target group and standard operation

This manual is for users and qualified personnel. The activities are only allowed to be carried out by appropriately trained personnel who are sufficiently qualified for the respective work involved.

#### 0.2.1 Qualification of target group

##### 0.2.1.1 Users

Users must be instructed by qualified personnel as follows:

- Instruction in hazards when handling electrical devices
- Instruction in the system's operation
- Instruction in the maintenance of the ComfoAir 70
- Knowledge of and compliance with this manual, including all safety instructions.

##### 0.2.1.2 Qualified personnel

Qualified personnel must have the following qualifications:

- Training in dealing with hazards and risks when installing and operating electrical devices
- Training for the installation and commissioning of electrical devices
- Knowledge of and compliance with the locally applicable building, safety and installation regulations of the relevant local authorities or municipalities, the regulations of the water and electric utilities, and other official regulations and guidelines
- Knowledge of and compliance with this document, including all safety instructions

Unless otherwise stated in this manual, only a recognized qualified person is authorized to install, connect up, commission, and to service the ComfoAir 70.

#### 0.2.2 Standard operation of the unit

This unit can be used by children aged 8 and over and also persons with reduced physical, sensory or mental abilities, or a lack of experience and knowledge provided that they are under supervision or have been instructed on the safe use of the unit and understand the risks that result from it. Children must not play with the unit. Children must not carry out cleaning and user maintenance without supervision.

## 1 Introduction and safety

The ComfoAir 70 is built to the current state of the art and the recognized safety regulations. The unit is subject to continuous improvement and development. This is why it is possible for your unit to deviate slightly from the description.

### 1.1 Proper use

#### 1.1.1 ComfoAir 70 ventilation unit

The ComfoAir 70 can be used for comfortable ventilation in living and office areas (with limitations in the commercial sector) at a normal room air humidity of approx. 40 – 70% RH, briefly up to approx. 80% RH. Any other type of use is considered as misuse. Extreme conditions (e.g. salty air or air polluted with chlorine) can damage the unit. For reasons of safety, it is prohibited to modify the product or to install components that are not explicitly recommended or distributed by Zehnder Group for this product.

#### 1.1.2 Control panels

The ventilation unit is equipped with an internal control panel. As an option, an external control panel can be connected to the unit using a cable of max. 25 m length. The external control panel is only suitable for use in indoor areas.

## 1.2 Safety

Always observe the safety regulations and installation conditions in the current operating manual. Failure to observe the safety regulations, installation conditions, instructions, warnings, and comments in this document can result in personal injury or damage to the unit.

### 1.2.1 Safety regulations

- Do not make any changes to the unit or to the specifications listed in this document. Such changes can cause personal injury or lead to reduced performance in the ventilation system
- Always comply with the general locally-applicable building, safety and installation regulations of the relevant local authorities, the regulations of the water and electric utilities, and all other official regulations
- Installation, commissioning, and maintenance must be carried out by an authorized person or company, unless otherwise stated in this document
- Always disconnect the unit from the power supply before you start working on the ventilation system
- Following installation, all parts that could lead to personal injury are protected by the housing. The unit cannot be opened without the use of a tool
- Do not disconnect the unit from the power supply unless instructions to the contrary are listed in the manual
- The control unit can be damaged by static charge; which is why you must always take measures to prevent electrostatic discharge when handling the control unit (e.g. antistatic wrist strap)
- Replace the filters (at least) every six months. This ensures a pleasant and healthy air quality, and the unit will be protected against contamination
- Only operate the unit with a closed housing
- Keep this document in the vicinity of the unit during the entire service life of the ventilation unit

### 1.2.2 Installation conditions

- Check that the installation area is frost-protected
- The acceptable temperature range for the air being moved is between -20 °C and +40 °C
- The unit must not be installed in rooms subject to explosion hazards
- When installing the unit, make sure that the applicable country-specific standards / regulations for compliance with protection zones when installing electrical systems in rooms with a bathtub or a shower are observed!
- The unit must not be used for extracting combustible or explosive gases
- The unit must be connected to a fixed 230 VAC / 50-60 Hz power supply
- To switch off from the mains, a disconnection system using a contact opening width in accordance with the conditions from overvoltage category III for complete disconnection must be provided
- Check whether the electrical installation is suitable for the maximum power of the unit. The values for the electrical input power can be found in the "Product data sheet" chapter
- Check that the installation area of the unit meets the requirements in the "General installation instructions" chapter

### 1.2.3 Symbols used

You will find the following symbols in this document:



**Important note!**



**Caution: Risk of affecting the operation of the ventilation system or damaging the unit!**



**Caution: Risk of personal injury!**

## 1.3 Warranty and liability

### 1.3.1 Warranty provisions

Warranty according to our general terms and conditions (<http://www.international.zehnder-systems.com/company/general-terms-and-conditions>). Warranty claims can only be asserted for material defects and/or design faults that have occurred during the warranty period. Repair work under the warranty conditions is only allowed to be carried out with the prior and written approval by Zehnder Group. A warranty on spare parts is only then given if those parts have been delivered by the manufacturer and were installed by a specialist technician recognized by the manufacturer.

**The warranty shall be null and void if:**

- the warranty period has elapsed
- the unit is operated without filters released by the manufacturer of the ventilation unit
- parts are installed that are not supplied by the manufacturer
- the unit is used improperly

- the defects occur as a consequence of an incorrect connection, improper use, or from system contamination
- unauthorized changes or modifications to the system are made

### **1.3.2 Liability**

The ComfoAir 70 was developed and manufactured for the decentralized and semi-centralized ventilation of living areas and functional rooms.

Every other use is deemed as "improper use", and can lead to damaging the ComfoAir 70, or to personal injury, for which the manufacturer cannot be held liable. The manufacturer shall not be liable for any kind of damage that can be attributed to the following causes:

- Failure to observe the instructions listed in this manual pertaining to safety, operation and maintenance
- Improper installation
- Installation of spare parts that were not delivered or stipulated by the manufacturer
- Defects as a consequence of an incorrect connection, improper use or from system contamination
- Normal wear

## **2 Instructions for the user and qualified personnel**

### **2.1 Product description**

The ComfoAir 70 is a decentralized or semi-centralized ventilation unit with waste heat recovery for a healthy, well-balanced, and energy-saving comfort ventilation. The unit can be used as a single room unit (replacing the air in one and the same room) or as a so-called isolated solution using an adjoining room connection. With this ComfoAir 70 application as a semi-centralized ventilation system, air can be extracted from the kitchen, bathroom, WC(s) using the adjoining room connections, and the fresh air introduced into the living room, bedroom, and children's room. The room network is used as an overflow area.

An enthalpy exchanger, which can transfer both humidity and heat owing to the physical characteristics, is used in the ComfoAir 70 for the waste heat recovery. The housing consists of a powder-coated steel plate, as well as covers made of aluminium in the RAL9016 colour scheme. The unit body, made from a high-quality polypropylene, is used for accommodating the essential unit components, and also makes sure there is the necessary heat insulation and unit soundproofing.

The ComfoAir 70 has two maintenance-free 24 VDC radial fans with electronic commutation. These fans and the control board receive the required operating voltage via an integrated 230 VAC / 24 VDC power supply unit.

By default, a filter (in filter class G4) is used in the unit for the outdoor air and the extract air. As an option, filters in class F7 with pollen filter quality can be used for the outdoor air.

The exterior wall panel is available in three different types of material: white aluminium, white ABS plastic, or stainless steel.

The ComfoAir 70 has shutters that, under specific working conditions, automatically close off the outdoor air and exhaust air sections in the unit.

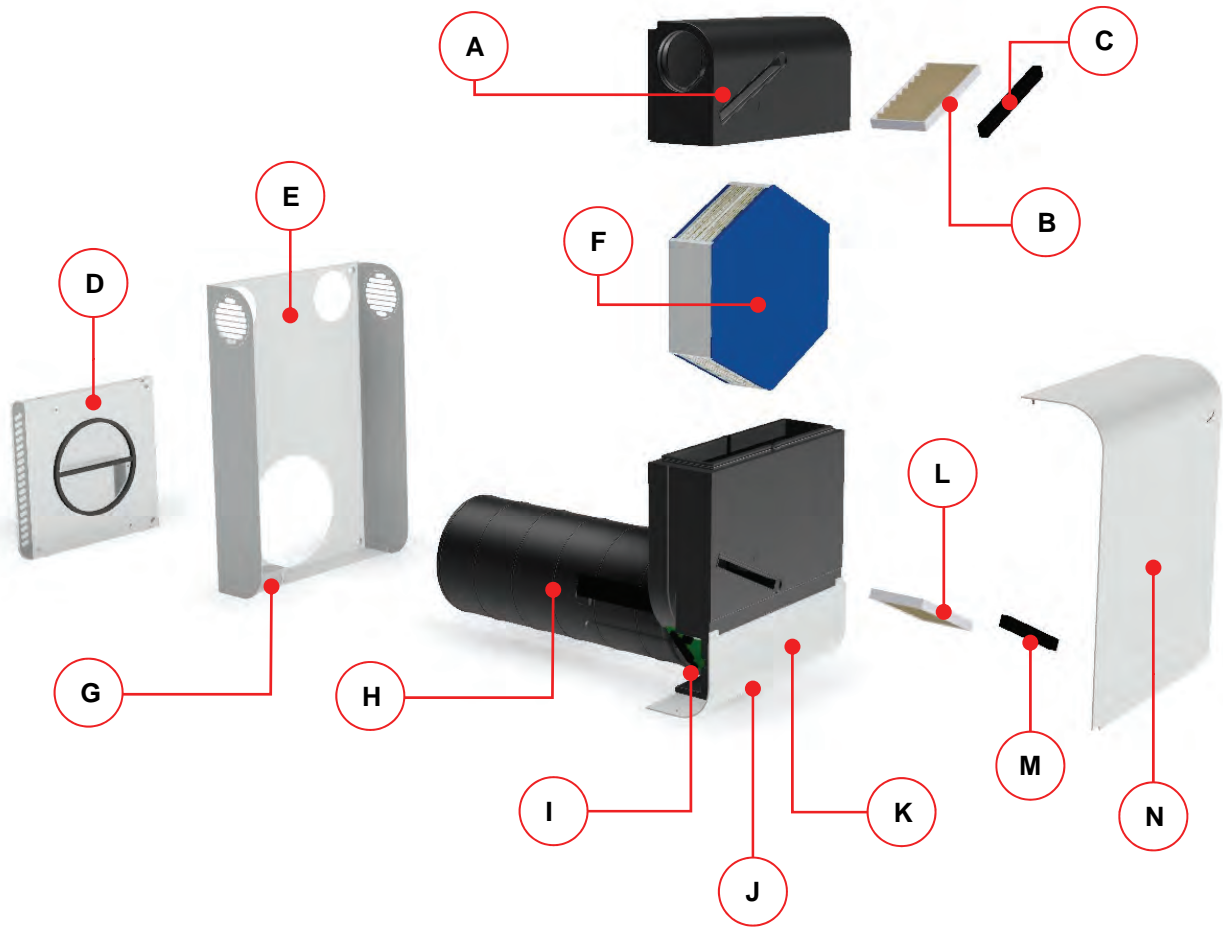

Item	Description
A	EPP housing, upper part
B	Extract air filter (G4)
C	Filter cover made of cellular rubber
D	Exterior wall panel (with swelling sealing tape stuck on rear side)
E	Wall bracket
F	Enthalpy exchanger (diaphragm moisture heat exchanger)
G	Connection socket
H	EPP housing unit with integrated fans and folding mechanism
I	Control board
J	Lower design cover made of aluminium, with integrated control panel
K	Touch-sensitive control panel
L	Outdoor air filter (G4 or F7)
M	Filter cover made of cellular rubber
N	Upper design cover made of aluminium

### 2.1.1 Type label

The type label identifies the product unequivocally. The type label can be found underneath the upper design cover, on the polypropylene unit core. You will need the details on the type label for the safe use of the product and in case of questions for service. The type label must be attached permanently on the product.

### 2.1.2 Frost protection

The ComfoAir 70 is equipped with an automatic frost protection control system, which prevents ice from forming in the heat exchanger at very low outdoor air temperatures. If needed, the frost protection mode is activated both in the four manual fan speeds and in the Automatic fan speed.



### 2.1.2.1 Frost protection mode

In frost protection mode, the ratio between the supply air and extract air volume flow is automatically adjusted depending on the outside air temperature by the control system, and the unit is shut down if the outside temperature is lower than -15 °C. A check is made regularly as to whether the temperature conditions in regard of frost protection have changed, and the respective operating mode (requiring frost protection) is activated automatically according to the result of that check.

### 2.1.3 Joint operation with fireplaces

Joint operation with fireplaces depending on the indoor air is only permissible in combination with the corresponding safety devices and in compliance with applicable laws, regulations, and standards.







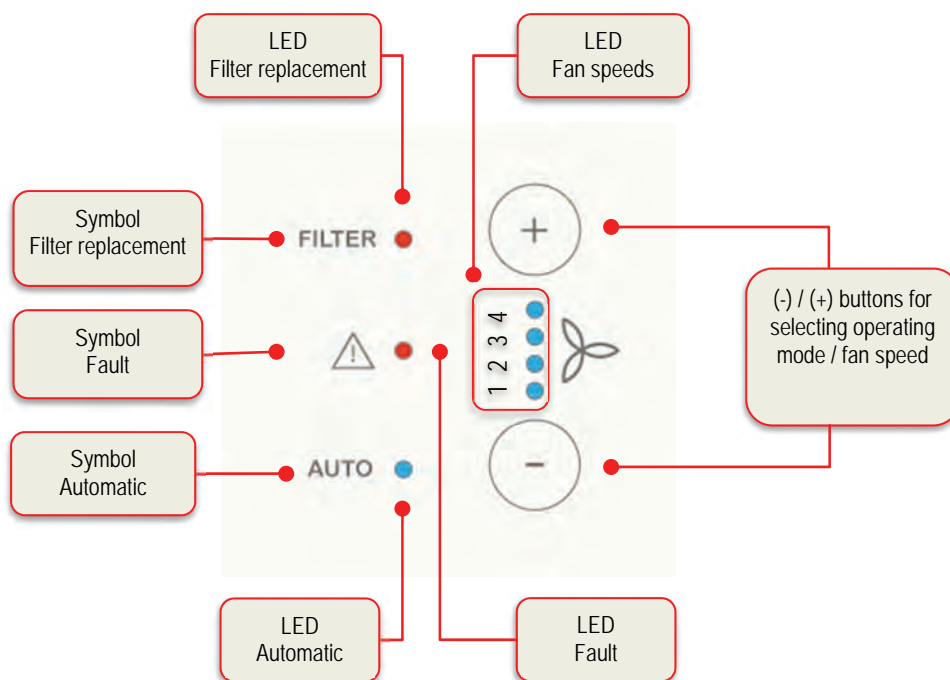

## 2.2 Functionality of the internal and external control panel



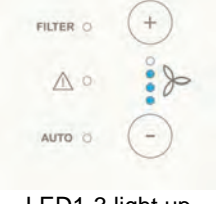



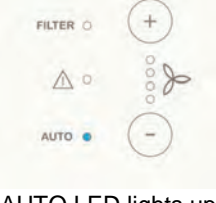

The control panels have touch-sensitive buttons, which means the respective operating functions are triggered by touching the relevant buttons. The ComfoAir 70 can be operated at the same time with the internal and the external control panel. The button assignments and the LED signalling in both control panels are identical in terms of functions.



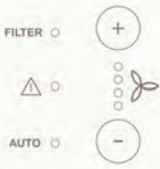
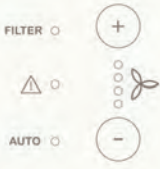

The two buttons are used for setting the various fan speeds and operating modes. The ventilation stages and the Automatic operating mode are indicated with blue LEDs, and the service information with red LEDs.



## 2.3 Operating functions and signalling from the control panel

Icon	Description	Explanation
 <p>LED1 lights up</p>	Fan speed operating mode  Fan speed 1 (FS1)	<p>The selection for the current fan speed (in total 4 fan speeds with preset speeds for each fan) is made by using the (-) / (+) buttons.</p> <p>Touching the (+) button sets the next higher fan speed and touching the (-) button sets the next lower fan speed.</p>
 <p>LED1-2 light up</p>	Fan speed 2 (FS2)	
 <p>LED1-3 light up</p>	Fan speed 3 (FS3)	
 <p>LED1-4 light up</p>	Fan speed 4 (FS4)	
 <p>AUTO LED lights up</p>	Automatic operating mode (AUTO)	<p> <b>The Automatic function can only be activated with a sensor module.</b></p> <p>Touching the (+) button from the currently active FS4 transfers the unit to AUTO fan speed. AUTO fan speed is exited by touching the (-) button, and the unit is transferred back to FS4. The Automatic function is visualized by the Automatic LED.</p>
 <p>AUTO LED lights up</p>	Bathroom function operating mode	<p> <b>The Bathroom function can only be activated with a sensor module and configured DIP switch setting.</b></p> <p>The fans are operated at maximum speed starting from a relative room air humidity of 80%. If this limit is not reached, the previously active operating mode is applied again.</p>

 <p>LED1-4 light up</p>	<p>Boost ventilation mode</p>	<p> <b>The boost ventilation function as temporarily activated fan speed 4 can only be activated with a configured DIP switch setting.</b></p> <p>After the boost ventilation time has elapsed, the unit will be transferred to the most recently selected fan speed. The fan speed that was active for longer than 10 s is deemed as the last fan speed. When boost ventilation is active, the operating modes "Extract air mode" or "Supply air mode", that may be activated, are retained.</p> <p>The boost ventilation time of 15, 30 or 45 minutes can be set by the Customer Service with the programming module. (Factory setting: 15 minutes)</p>
 <p>LED1 lights up during the active time phase</p>	<p>Away mode</p>	<p> <b>The Away function as temporarily activated fan speed 1 can only be activated with a configured fan speed 1.</b></p> <p>The active operating time of the fan speed 1 of 15, 30, or 45 min/h can be set with a programming module by customer service. (Factory setting: 60 min/h <math>\triangle</math> FS1 permanent operation).</p>
	<p>LED display for energy-saving mode</p>	<p>The LED display on the control panel changes after 10 seconds into energy-saving mode without operator input (unit functions remain active; the LED display is switched off). If any button is touched, the LED display will be activated again. Touching the button brings about no change to the operating mode, however.</p>
	<p>Standby mode</p>	<p>The unit can be switched from FS1 to Standby mode by touching the (-) button. The fans then come to a stop.</p> <p> <b>The shutters are closed automatically!</b></p> <p>Standby mode is exited by touching the (+) button. The unit will start with fan speed 1.</p> <p> <b>The shutters are opened automatically!</b></p> <p>There is no indication of the Standby mode from the LEDs of the control panel.</p>
 <p>LED1 flashes in alternation with the current fan speed</p>	<p>Extract air mode</p>	<p>Touching the (-) button for 5 seconds in operating modes FS1 to FS4 activates or deactivates the Extract air mode. The supply air fan is switched off; the extract air fan continues to run with the current fan speed.</p> <p>The display for the current fan speed alternates every 2 seconds with the flashing LED1.</p> <p>To avoid condensation appearing on the outer panel, the unit automatically changes to the frost protection mode when the frost protection temperature is reached. The supply air fan is activated for several minutes every hour in order to record the correct outside air temperature.</p>
 <p>LED4 flashes in alternation with the current fan speed</p>	<p>Supply air mode</p>	<p>Touching the (+) button for 5 seconds in operating modes FS1 to FS4 activates or deactivates the Supply air mode. The extract air fan is switched off; the supply air fan continues to run with the current fan speed.</p> <p>If the outdoor temperature falls below 13 °C, the extract air fan will be activated.</p> <p>The display for the current fan speed alternates every 2 seconds with the flashing LED4.</p>

 <p>LEDs1-3 flash Flashing of most recently active fan speed when supply air fan is switched off (Display of LED1-3 as example)</p>	<p>Frost protection mode</p>	<p>A temperature threshold, which activates its own frost protection routine if not reached, is stored for each fan speed. The fan speed of the supply air will be regulated linearly between the minimum and maximum set point when the outside temperature is dropping. The fan speed can still be changed.</p> <p>The supply air fan is deactivated if a second temperature threshold is not reached.</p> <p>If the outside temperature falls below the temperature limit threshold of -15 °C, the extract air fan will also be deactivated and the unit switched off.</p> <p>After the unit is switched off, a flashing in those LEDs (by touching the (-) or (+) button) which denoted the most recently active fan speed will be signalled. The fan speed cannot be changed and is signalled with the flashing of Fault LED.</p> <p> <b>The shutters are closed and opened automatically depending on the current frost protection routine!</b></p>
 <p>Fault LED flashes</p>	<p>Indication of locked modes</p>	<p>If an inaccessible operating mode is selected, it will be signalled by the flashing of Fault LED.</p> <p>These operating modes are the locked standby, locked supply and extract air mode and complete switch-off due to frost protection.</p>
 <p>LED Filter replacement flashes</p>	<p>Indication of filter inspection</p>	<p>The filters are monitored based on running time. 90 days are preset by default.</p> <p>After the filter runtime has elapsed, notification in regard of a filter inspection is signalled by the filter replacement LED flashing.</p> <p>Simultaneously touching the (-) and (+) button for 3 seconds allows you to acknowledge the indication of the filter inspection and to reset the filter runtime.</p>
 <p>Fault LED lights up Error code LED1-4</p>	<p>Signalling of error code fault message</p>	<p>If an error occurs, this is signalled by the fault LED.</p> <p>Faults that can be diagnosed by the unit are symbolized by LED1-4 using an error code (see 3.4.1).</p> <p>Simultaneously touching the (-) and (+) button for 3 seconds allows you to delete the indication of the fault notification.</p>

### 2.3.1 Automatic operating mode



**Automatic operating mode requires an internal installation and configuration of a sensor module! The sensor modules inserted in the extract air section of the ventilation unit are available as optional accessories.**

**The Automatic function changes into the frost protection operating mode in the event of frost protection criteria being met!**

The application of the Automatic function follows the logic of a demand controlled system for optimizing the indoor air quality. Consequently, an optimized response is achieved and mildew formation is prevented, which ultimately also leads to an increase in energy savings.

The ComfoAir 70 ventilation unit with a sensor module is classified in energy efficiency class A.

### 2.3.1.1 Functional principle of HUMIDITY sensor



**The HUMIDITY sensor module is primarily supposed to be installed in units for the ventilation of rooms with an increased occurrence of humidity.**

The HUMIDITY sensor module is equipped with a humidity and temperature sensor and calculates the relative humidity. In the evaluation of the current sensor signal for the setpoint selection, the fans are regulated in accordance with the characteristic curve in diagram 1. Since the dehumidification performance decreases the smaller the temperature difference between indoor and outdoor air, at a difference of  $\Delta T < 5$  K the air volume is reduced to 20 m<sup>3</sup>/h. When the Bathroom function operating mode is active, the unit will be operated with the highest fan speed if the relative humidity amounts to 80% or more.

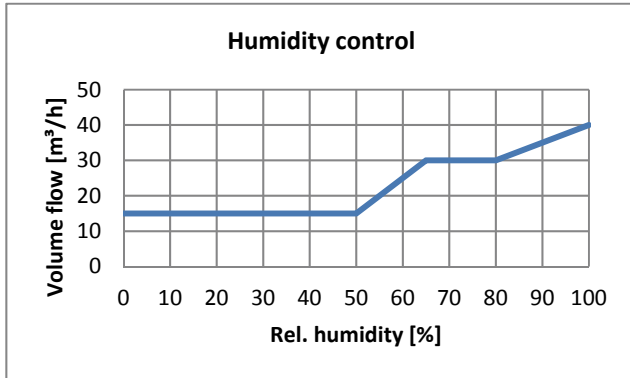

Diagram 1: Factory setting characteristic curve for Automatic operating mode with humidity control

### 2.3.1.2 Functional principle of CO<sub>2</sub> / VOC sensor



**The CO<sub>2</sub> sensor module and the VOC sensor module are each combined with a humidity/temperature sensor.**

The CO<sub>2</sub> sensor module and the VOC sensor module both offer the option to evaluate relative air humidity as well as the air quality for controlling the ventilation unit. The VOC sensor module detects volatile organic compounds (VOC) and the CO<sub>2</sub> sensor module, as NDIR sensor (nondispersive infrared sensor), detects carbon dioxide (CO<sub>2</sub>). Volatile organic compounds correlate really well with the CO<sub>2</sub> concentration in living spaces. In the evaluation of the current sensor signal for the setpoint selection, the fans are regulated in accordance with the characteristic curve in diagram 2.

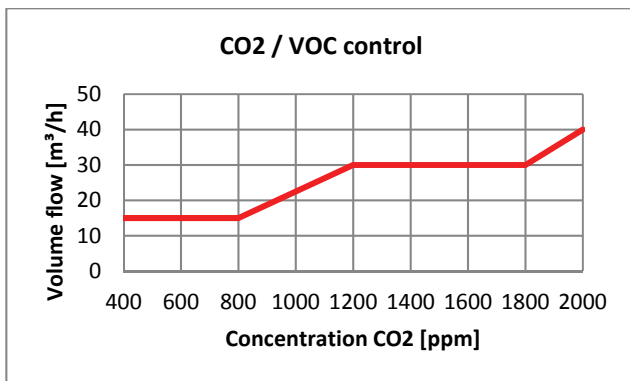

Diagram 2: Factory setting characteristic curve for Automatic operating mode with CO<sub>2</sub> / VOC control



**The CO<sub>2</sub> and VOC sensor modules combined with a humidity/temperature sensor can be deactivated separately if needed, in accordance with the humidity or air quality control. If both sensor modules are configured as active, the control characteristic of the sensor module is designed with the greater sensor signal.**

**The required hardware settings on the control system are only allowed to be made by qualified personnel!**

## 2.4 Maintenance by the user



**If the maintenance work is not carried out regularly, this will affect the functionality of the decentralized ventilation unit in the long run!**

**Replace the filters at least every six months. This ensures a pleasant and healthy air quality, and the unit will be protected against contamination.**

The maintenance of the ventilation unit for the user is limited to changing the filters periodically and to cleaning the unit on the surface, if needed. Check the filters if this is indicated by the filter replacement LED.



**Cleaning the surface of the unit, and specifically the control panel, is possible using a damp cloth and a mild soap solution. Never just wipe it dry!**

Unsuitable cleaning agents are:

- Alcohol (> 5%)
- Acetone
- Benzene or carbon tetrachloride
- All types of "strong" cleaning agents
- Scouring agents
- Glass cleaners and similar



**Instructions for units with an adjoining room connection!**

The filter mats should be replaced or cleaned on the extract air valves (e.g. bathroom, kitchen, WC) every 2 - 3 months or when checking the degree of contamination at one's own discretion.

### 2.4.1 Replacing the unit filters



**The ComfoAir 70 must not be operated without filters. When changing filters, the unit needs to be transferred to the Standby operating mode.**

In ComfoAir 70, two high-quality original filters of the class G4 are installed by default. Retrofitting a pollen filter of the class F7 is possible. This is inserted into the lower filter compartment (outdoor air filter). The filters in the ComfoAir 70 must be checked in accordance with the relevant notification on the control panel and, if needed must be replaced. In doing so, proceed as follows:

1. Put the unit into the Standby operating mode.
2. Remove the upper design cover by pulling it out of the guides in an upwards direction.

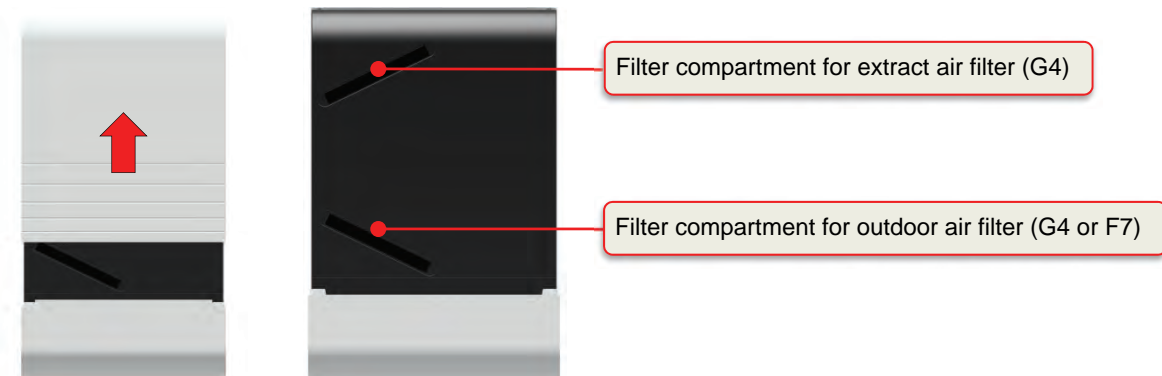

3. Use your finger to go into the recess between the filter cover made of cellular rubber and the EPP housing, and pull the filter cover out.





4. Gripping the pulling tabs, pull the filter carefully out of the filter compartment.

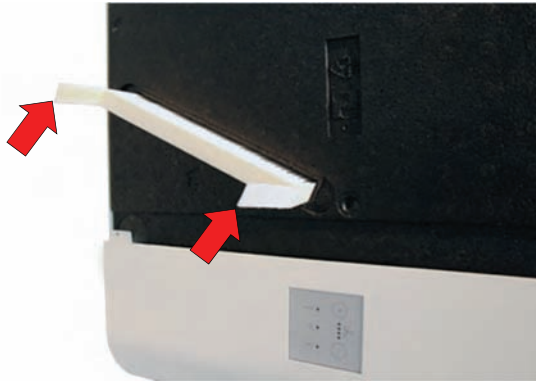

5. Using the directional arrow of the filter label pointing to the centre of the unit, insert the new filter into the filter compartment. Make sure that the filter is not pushed into the housing with force.



6. Insert the filter covers again so that the filter compartment is filled evenly.
7. Proceed in the same way for the upper unit filter.
8. Put the upper design cover onto the unit from above. Make sure that it engages, both in the guide for the lower design cover as well as with the locking nipples, into the designated spring clips of the wall bracket.



9. Switch the unit back into the desired operating mode.

#### 2.4.2 Resetting the filter runtime

After completing the filter replacement, the meter for the filter runtime must be reset. To do this, you can clear the filter inspection indication again by touching the (-) and (+) button for 3 seconds. The red LED on the control panel, symbolizing the filter replacement, switches off.

#### 2.4.3 What should I do in case of a malfunction?

Contact the installation technician in case of a malfunction. Note down the type of your ComfoAir 70; for more on this, see the type label underneath the design cover of the unit.

The mains connection must always be present, providing the ComfoAir 70 does not have to be shut down due to a serious malfunction, maintenance work, or due to another urgent cause.



***As soon as a mains disconnection is made, the apartment will no longer be mechanically ventilated. This makes it possible for problems involving moisture and mould to occur in the apartment. A longer period of being switched off, particularly during the summer months, brings about the danger of accumulating contaminants in the inside of the exterior wall panel and in the EPP housing section of the pipe extension!***



***The ventilation unit must be permanently left in operation, excepting times needed for maintenance and repair work. The unit should be operated in the Away mode for the duration of an absence!***

## 2.5 Disposal

Discuss with your supplier what you should do with your ComfoAir 70 at the end of its life cycle. If you cannot return your ComfoAir 70, do not deposit it in the normal household waste, but rather contact your local authority for options to recycle components or to process materials in an environmentally-friendly way.

## 3 Instructions for the qualified personnel

### 3.1 Installation requirements

The following requirements must be assured for the correct installation:

- Installation in accordance with the general and locally-applicable safety and installation regulations from, among others, the electric utility, and in accordance with the regulations stipulated in this manual
- Outside wall with final construction thickness of minimum 275 mm
- Sufficient clearance to objects and for maintenance work (at least 10 cm on extract air side, 20 cm on the supply air side, 80 cm at the front, and 20 cm above the unit), with regard to the housing surfaces when installed
- Recommended suction opening for the outdoor air with respect to the ground >1 m, however, at least unpolluted air in the suction area
- 230 VAC, 50-60 Hz power supply for fixed units

#### 3.1.1 Transport and packaging

Proceed with care when transporting and unpacking the ComfoAir 70. The ventilation unit and the outer panel are packed in a transport-safe box.



***Do not damage or dispose of the packaging before final installation of the ventilation unit.***

#### 3.1.2 Checking the scope of delivery

If damages or incompleteness should be determined at the delivered product, please contact the supplier immediately. Included in the scope of delivery are:

- ComfoAir 70, including installation kit
- Exterior wall panel, including installation kit
- Mounting template as imprint on the inside of the lid of the box
- Operating and installation instructions
- Product labels for energy-efficiency label



***For devices with adjoining room connection, you should use accessories of the Zehnder product portfolio for installation of the air ducts.***

## 3.2 Installation

### 3.2.1 General installation instructions

The ComfoAir 70 is only designated for installation in an outside wall, whereby the housing for the unit must be on the inner side, in a vertical position. To mount the ventilation unit, a wall mounting pipe must be installed into the outside wall in advance; please refer to the respective installation instructions enclosed for the procedure for installing the wall mounting pipe.



***When planning the installation location, please note that the clearance needs to be 10 cm on the extract air side and 20 cm on the supply air side for the intended operation of the standard variant. For maintenance work, clearances of 80 cm in front of the unit and 20 cm above the unit are to be adhered to!***





**The unit has the protection class IP20. Make sure that the applicable country-specific standards / regulations for compliance with protection zones when installing the unit in rooms with a bathtub or shower are observed!**

### 3.2.2 Installation preparations

Prior to installing the ventilation unit, an appropriate wall mounting pipe must already be installed in the outside wall at the designated installation location. It must be adjusted flush with the level of the finished wall construction.



**The installation of the ComfoAir 70 is only allowed in connection with the round wall mounting pipe or with the square wall mounting pipe!**

The square wall mounting pipe, intended in particular for new buildings, should be integrated in the outside wall construction in the course of the wall construction. The round wall mounting pipe is primarily used in the refurbishment and reconstruction of the building fabric, and is inserted in the outside wall by means of a core hole ( $\varnothing$  270 mm).



**Observe the respective enclosed instructions on professional installation when installing the wall mounting pipe. Use the mounting template in order to transfer all centrings for the holes onto the inner wall surface.**



**A 230 VAC mains connection for fixed units is to be prepared on site for the mains power supply.**



**In order to connect an external control panel, a cable must be installed on site between the control panel and ventilation unit (recommendation: type J-Y(ST)Y 2x2x0.6 LG indoor cable with colour coding in accordance with VDE 0815).**

The mains supply line (e.g. NYM-J 3x1.5) and, where applicable, the cable to the external control panel, must be installed flush-mounted up to the area of the bottom left side of the unit. The cable ends should protrude approx. 10 cm out of the wall surface in the area of the cable entry point.

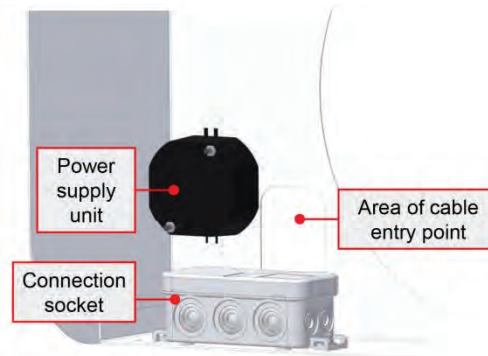
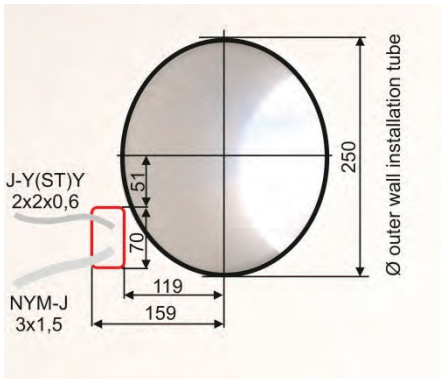

### 3.2.3 Connecting the ventilation tubes (only for adjoining room connection)



**The installation of the ventilation tubes and the necessary accessories (adapters, bends, sealing tape) should be done prior to installing the ventilation unit.**

The following points must be observed when installing the ventilation tubes:

- You have the choice of installing the ventilation tubes either at the side or behind the unit
- Install the ventilation tubes air-tight at the designated connectors. To do so, use the recommended sealing tape (accessory items). The sealing tape should be moistened with silicone spray so that the connection for the ventilation tube with the housing takes place more easily
- In order to install at the back of the unit, remove the blanking plugs from the EPP housing, and install the ventilation tubes from the other ventilated room. Use the attached blanking plugs, that are covering the room connections behind the unit in the delivery state, in order to close off the side connections
- Remove the grille by the two webs



#### Adjoining room connection from behind:

- Recommendation: Use the "90/75 to flat 51 adapter" and route the duct into the insulation layer of the outside wall insulation.



#### **Restrictions when installing the flat 51 flat duct on the inner wall!**

When using the adapter "90 to flat 51 / bend 90° adapter" (item number 990 322 046), the connecting flat51 flat duct must be routed in a downward direction, and then only using a 90° angle ("Bend flat 51 H") to the left or to the right.

The reason for this is the fixing point of the wall bracket located next to the respective adjoining room connection, where the fixing point is not allowed to be located in the vicinity of the flat duct.

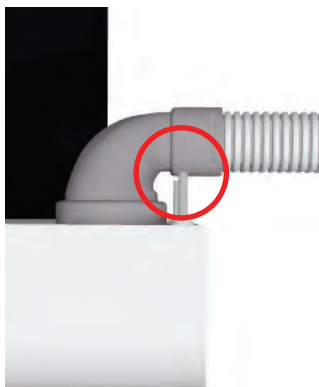

An exception here is mounting the unit on drywalls or on an in-wall installation. Since the wall bracket here is fastened on the drywall, the flat duct can also be routed behind the wall, without having to get into a collision with the short fasteners (e.g. plasterboard wall plugs) then being used. Please observe the shorter screw or wall plug lengths of maximum 35 mm to be used then.

For correct installation, the appropriate adapter for the flat51 system must protrude 27 mm out of the wall, so that the connector is inserted 22 mm in the EPP body following installation.



#### Adjoining room connection to the side:

- If a side exit for the ventilation tubes is being used, leave the blanking plugs in the behind connector, and only separate the ventilation grille on the aluminium housing from the required connection side.



**Install the connecting pipe flexibly so that, when installed, it can be disconnected from the unit again for later servicing work (pipe must be able to be withdrawn from the connector)!**



- The self-adhesive sealing tape must be stuck over the entire circumference of the connector on the outside, namely 10 mm away from the front end of the connector. That end of the adapter (together with the stuck-on sealing tape) is inserted 35 mm into the EPP body for installation purposes.



**wall!**

***Make sure, even after plastering the inner wall, that the pipe still protrudes far enough out of the***

- For the connection to the second room, use a  $d_a = 100$  mm pipe connection, or use the Zehnder flat duct, flat 51, with the aid of an adapter.
-  ***The ventilation tubes in an adjoining room connection have an effect on the volume flow balance of the ventilation unit. The balance adjustment must be produced in accordance with the system characteristics curve by using the PC software.***

### 3.2.4 Installing the ventilation unit



***Prior to starting work, ensure that the mains supply line has no voltage!***



***Check in advance the required carrying capacity of the respective mounting surface (dead weight of the ComfoAir 70 is 22 kg) and the secure mounting option using wall plugs and screws of sufficient length. The supplied mounting material should only be considered as a suggestion.***



***Use the mounting template as an aid for the bore holes. Prior to installing the unit, remove the upper and lower design covers. Unplug the plug connection for the ribbon cable on the internal control panel.***



***A sensor module (optional accessories) must be fitted in the unit before the unit is installed!***

Proceed as follows for the installation of the unit:

1. Pull the upper outer cover upwards and out of the bracket, and undo the two screws to remove the lower design cover.



2. Lift the lower outer cover slightly, and pull the ribbon cable on the inner side of the design cover, gripping the red plug, carefully off the board of the internal control panel.



3. Remove the wall bracket from the EPP housing so that the unit is now available with no housing components.
4. Drill the four holes in accordance with the mounting template for fixing the wall bracket, and insert the supplied, or, depending on the wall construction, relevant mounting material (wall plugs) into the holes.



***Should the centrings for the bore holes not be available, the drill holes can be transferred afterwards onto the inner wall surface by means of vertical alignment and central application of the wall bracket in relation to the pipe axis!***

5. Screw the wall bracket to the inner wall, and take care to ensure that the mains supply line and, if present, the cable for the external control panel, are guided through in the area of the cable entry point.



***If the inner wall surfaces are uneven, or it is not vertical, then the wall bracket must be aligned using suitable tools (spacers or something similar).***



6. Connect the power supply in the connection socket in accordance with 3.2.5.1 and, if present, connect the external control panel on the unit side, in terms of the plug-in connector part with the screw-type terminals in accordance with 3.2.5.2.1.
7. If necessary, shorten the EPP pipe to the length of the wall mounting pipe +5 mm, or the wall thickness, so that it is also flush with the façade.



**The cut must be performed all around, perpendicular to the axis of the EPP pipe extension!**



8. As shown below, push the ventilation unit, with a clearance up to approx. 15 cm to the wall bracket, into the wall mounting pipe so that the control board still remains freely available.



**In order to make it easier to insert the ventilation unit, you should deburr the cutting edge of the EPP pipe, and spray some silicone spray into the wall mounting pipe!**



9. Before you push the ventilation unit in completely, the power supply 3.2.5.1, internal control panel 3.2.5.3, and, where applicable, external control panel 3.2.5.2, are to be connected electrically with the control board.
10. Fasten the lower design cover using the left-hand screw. The lower design cover can now be pivoted. Plug the ribbon cable onto the control panel in the position shown.



11. Push the unit into the wall mounting pipe as far as it will go, taking into account the electrical connections.





**Take care to ensure that the EPP housing rests on the wall bracket with the lower side. If necessary, push the upper frame of the wall bracket slightly upwards.**

**In the end position, the front side of the EPP housing has to line up with the front edge of the wall bracket, or stand back somewhat behind it; if necessary, the wall bracket must be adjusted using spacers.**

12. Pivot the lower design cover against the EPP housing. In the process, press the lower design cover slightly away from the wall bracket in order to pivot it in front of and past the edge of the wall bracket without a collision occurring.

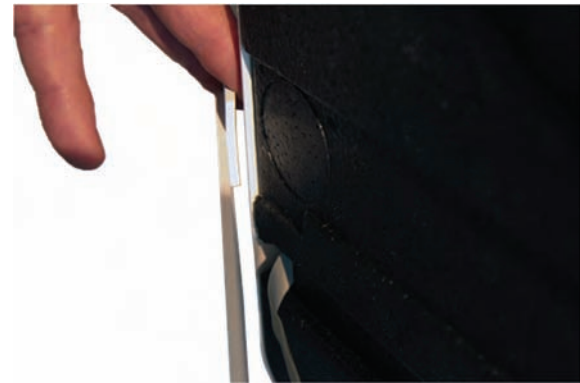

**Take care to ensure that the ribbon cable is located in the designated recess of the EPP housing when installing the lower design cover.**

13. Fix the lower design cover in place on the wall bracket using the two screws, and put the upper design cover onto the EPP housing, whilst taking the instructions given in 2.4.1 into account.



### 3.2.5 Electrical connections



**Electrical connections are to be implemented in accordance with the existing standards specific to the relevant country, and must only be performed by qualified personnel!**

#### 3.2.5.1 Connection for power supply



**Prior to starting work, ensure that the mains supply line has no voltage!**



**On-site, a disconnection system has to be installed using a contact opening width in accordance with the conditions from overvoltage category III for complete disconnection in the fixed electrical installation, in accordance with the installation regulations.**

1. Guide the mains supply line and the power supply unit's primary-side power cable into the connection socket.



**In accordance with protection class II (protective insulation), the wires for the mains supply line and the wires for the primary-side power cable of the power supply unit must be installed into the connection socket with double insulation through the cable bushings!**

2. Slip a WAGO luminaire terminal from the installation kit, together with the plug connection for solid conductors, onto one wire of the mains supply line respectively.

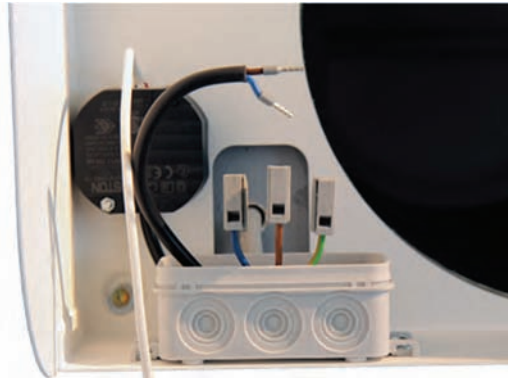
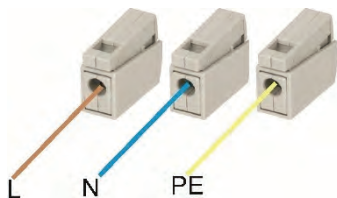

3. Connect one wire from the primary-side power cable of the power supply unit respectively to the clamping connection for the stranded wire of the WAGO luminaire terminal for the L-conductor and the N-conductor. The WAGO luminaire terminal of the PE conductor remains unassigned (ventilation unit corresponds with protection class II – protective insulation).

Wires for primary-side cable, power supply unit

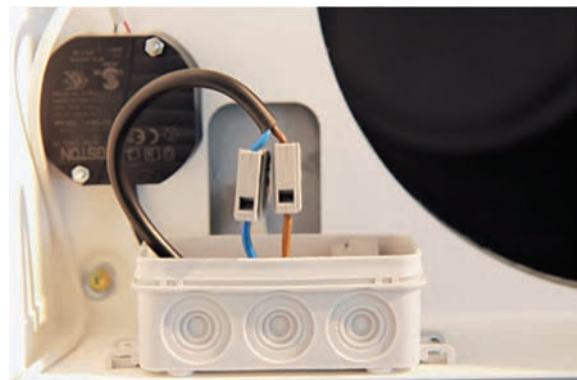
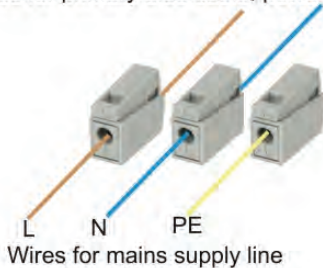

4. Get the clamping connections in the connection socket and close them using the cover.



5. Connect the wires of the secondary-side low-voltage cable of the power supply unit to the 24 V X6 terminal on the control board.



**Watch out for the secondary-side, polarity-dependent terminal assignment!**

Colour coding Low-voltage cable power supply unit	Clamping point for 24 V X6 terminal
red	+
black	-

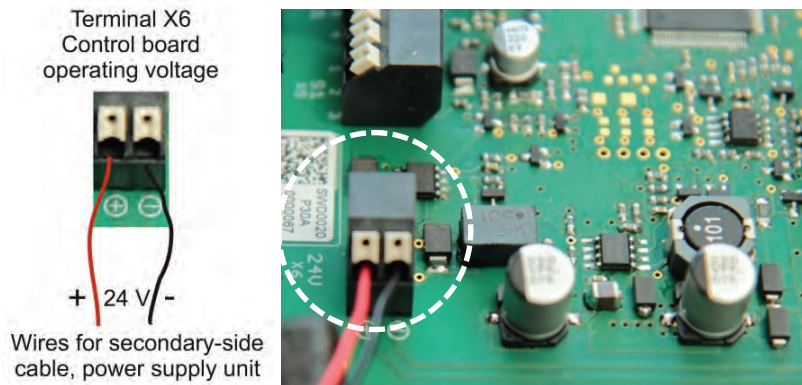

### 3.2.5.2 Connecting the external control panel



**The unit-side connection of an optionally available external control panel must be established in the course of connecting the power supply.**

#### 3.2.5.2.1 Connecting the cable for the external control panel on the ventilation unit

The cable end of the on-site cable (J-Y(ST)Y 2x2x0.6), protruding in the area of the cable entry point, for the external control panel must be connected up as follows:

1. Pull the plug-in connector part with the screw-type terminals off the 4-pin plug connection of the pre-assembled connecting cable (contained in scope of delivery kit, external PDA control panel).



2. Connect the four wires of the on-site cable (J-Y(ST)Y 2x2x0.6) for the external control panel to the plug-in connector part with the screw-type terminals.



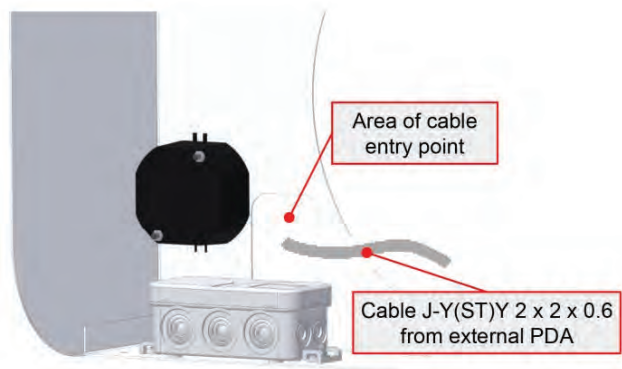

**Note down the colour of the wires in accordance with the assignment of the clamping points. This assignment for the colour coding must match up with the assignment of the clamping points on the external control panel! Enter the colour coding in the table below in order to have the assignment available so that it can be reproduced when the external control panel is removed.**

Colour coding connecting cable	Clamping point for plug connection	Colour coding Cable for external control panel
white	-	
yellow	A	
green	B	
brown	+	

3. Connect the wires of the connecting cable to the BUS X7 terminal on the control board.



**Watch out for the correct assignment of the wires in accordance with the assignment of the BUS X7 terminal**

Colour coding connecting cable	Clamping point for BUS X7 terminal
white	-
yellow	A
green	B
brown	+

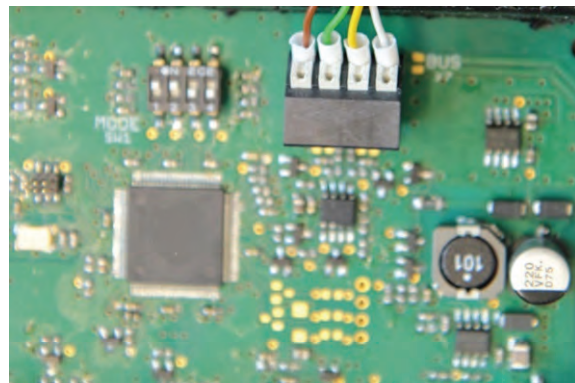
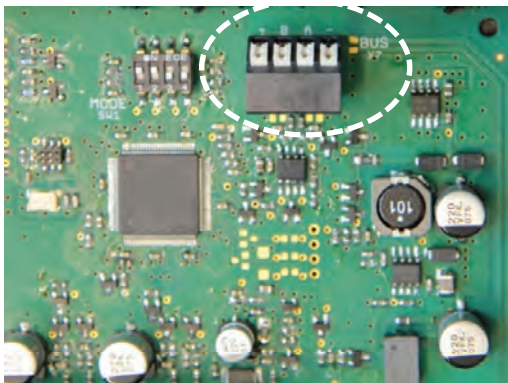

4. Connect the plug-in connector part for the connecting cable with the plug-in connector part of the cable for the external control panel.

### 3.2.5.2.2 Connecting the cable on the external control panel

Connect the cable to the spring-type terminals for the connection board of the external control panel as depicted.



**Watch out for the correct assignment of the wires in accordance with the assignment of the plug connection!**

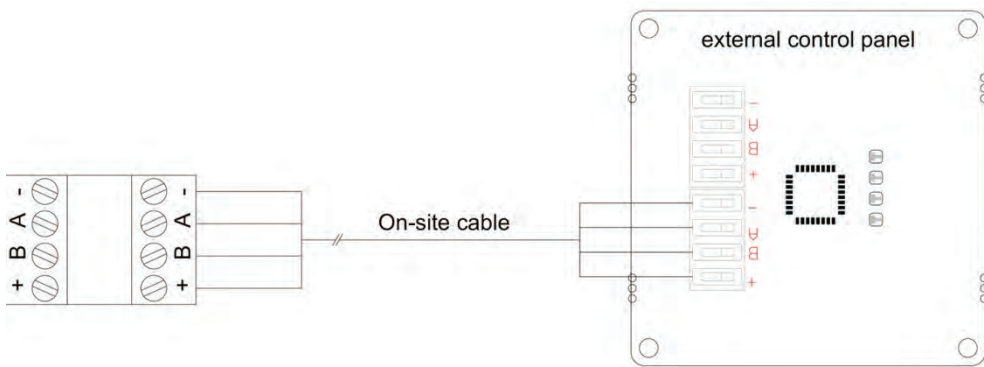

### 3.2.5.3 Connecting the internal control panel

The internal control panel must be connected to the control board using the ribbon cable.

1. Firstly, plug the connector for the one cable end (in the position shown) into the designated X9 socket on the control board.

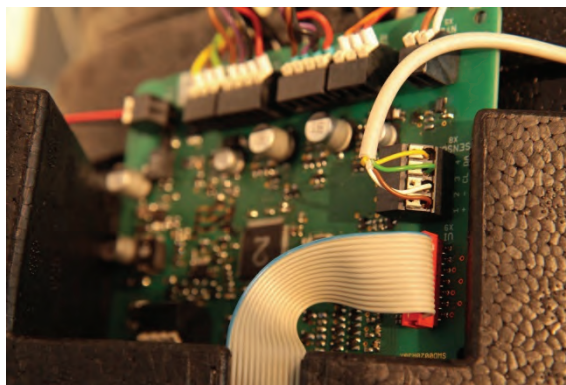
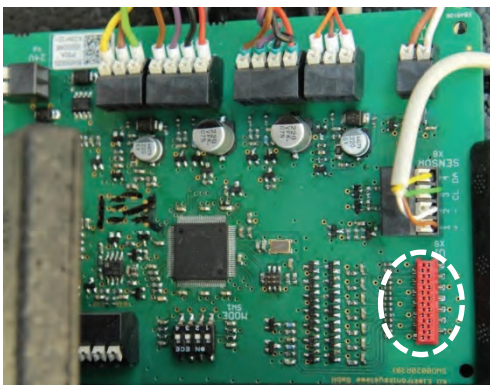

2. Plug the connector of the other cable end onto the control panel (in the position shown).



**Take care to ensure that the ribbon cable is located in the designated recess of the EPP housing when installing the lower design cover.**

### 3.2.5.4 Installing and connecting the sensor module



**The installation and connection of a sensor module should be carried out prior to installing the ventilation unit.**



**In the event of a later installation, the ventilation unit has to be withdrawn far enough out of the wall mounting pipe until the EPP housing is located in front of the side edge of the wall bracket.**

Following removal of the upper and lower design covers, proceed as follows:

1. Pull off the upper part of the EPP housing, and guide the sensor cable, together with the wire ends, from the inside to the outside through the hole in the EPP housing.

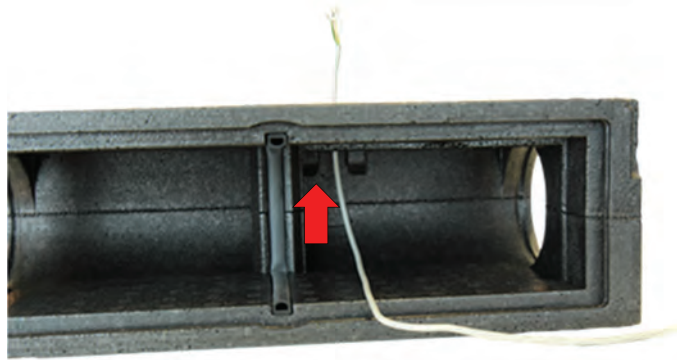
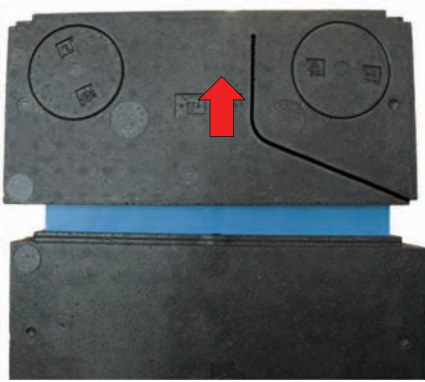

2. Clamp the sensor module into the fixation recess of the EPP housing, bearing in mind the cable routing.



3. Put the upper EPP housing section onto the lower EPP housing. Install the sensor cable at the behind and side in the designated cable recess on the EPP housing sections so that the cable ends in the vicinity of the control board.

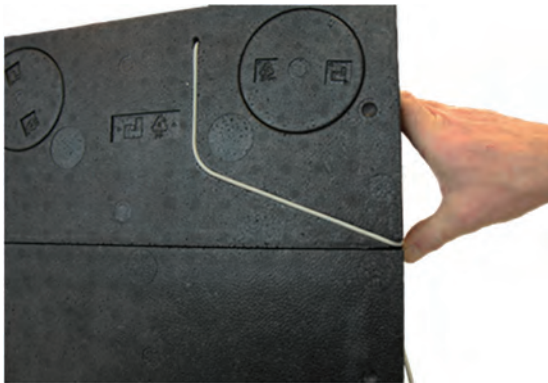

4. Connect the cable to the clamping point SENSOR X8 on the control board.



**Watch out for the correct assignment of the wires in accordance with the assignment of the SENSOR X8 terminal!**

Colour coding for sensor cable	SENSOR X8 clamping point	Signal
brown	1	+
white	2	-
green	3	CL
yellow	4	DA



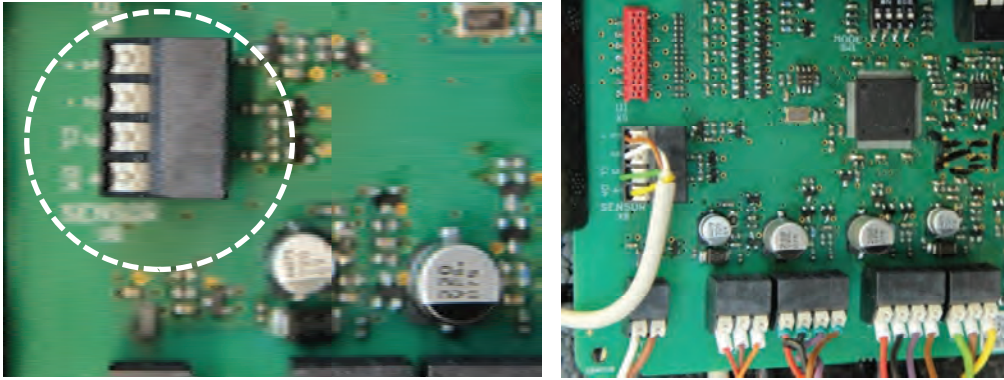

5. The four-pin DIP switch MODE SW1 is used for the configuration of the Automatic function for the respective sensor module. If necessary, correct the positions of the DIP switches in accordance with designated functional principle of the Automatic mode.

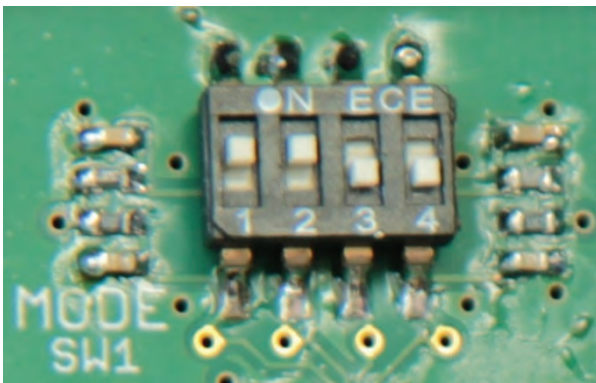

Fig. Position of DIP switch, factory setting

### 3.2.6 Parameterizable operating modes

#### 3.2.6.1 Configuration of Automatic operating mode

The DIP switch MODE SW1 can be used to configure the Automatic operating mode for various functional principles. The use of the Bathroom function requires the release of the HUMIDITY sensor module (DIP switch no. 2 of MODE SW1 in ON position).

DIP switch no.				Activated Automatic function
1	2	3	4	
ON	OFF	OFF	OFF	VOC / CO <sub>2</sub> control
ON	ON	OFF	OFF	VOC / CO <sub>2</sub> control and HUMIDITY control
OFF	ON	OFF	OFF	HUMIDITY control
OFF	ON	OFF	ON	HUMIDITY control with Bathroom function
ON	ON	OFF	ON	VOC / CO <sub>2</sub> control and HUMIDITY control with Bathroom function

#### 3.2.6.2 Configuration of the boost ventilation mode

The temporarily active fan speed 4 operates as the boost ventilation function. To enable boost ventilation mode, DIP switch no. 3 in MODE SW1 must be set to the ON position.

DIP switch no.	Position of DIP switch
3	ON

The boost ventilation time of 15, 30 or 45 minutes can be adjusted with the programming module.

#### 3.2.6.3 Configuration of the Away mode

The temporarily activated fan speed 1 operates as the Away function.

The active operating time of fan speed 1 of 15, 30, or 45 min/h can be parameterized with a programming module.

### 3.2.7 Installing the exterior wall panel



**For the installation of the exterior wall panel, one needs to make sure that a falling is prevented by secure fixing! Supplied installation accessories must, if necessary, be replaced on-site with appropriately suitable mounting material depending on the design of the façade. The responsibility for professional, safe installation lies with the performing technical crew!**



**The exterior wall panel should not be installed until the façade is completed, however, immediately following installation of the ventilation unit! Check the flatness between the wall mounting pipe, the EPP pipe housing, and the façade surface!**

Proceed as follows for the installation of the exterior wall panel:

1. Remove the top cover from the exterior wall panel.



2. Place the bottom cover exactly onto the contour of the EPP housing unit on the outside wall side. The side air passage openings for the bottom cover are directed diagonally downwards.



3. Transfer the centre points of the slotted holes onto the façade.



**The partition between the outdoor air and exhaust air guide should be in a horizontal position and also match up with the partition of the EPP pipe housing!**

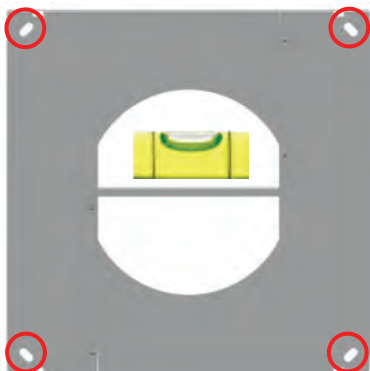

4. Prepare a suitable fastening technique for the four attachment points, in accordance with the façade design.
5. Stick the self-adhesive swelling sealing tape supplied with the installation kit onto the rear contour of the airflow openings on the bottom cover.



6. Install the bottom cover of the exterior wall panel onto the façade.



***When screwing the bottom cover to the wall, the bottom cover must not bend! If necessary, undo the screws again so that the bottom cover is still applied tightly to the façade, but this does not cause any deformation.***

***To protect against penetrating water, the gap between the bottom cover and the façade should be sealed using a suitable sealant (weatherproof acrylic)!***

7. Fix in place the top cover to the bottom cover using two screws respectively from the supplied installation kit.



***In general, the top cover must be secured using additional fixing at 4 points!***

### 3.3 Maintenance and repair by the qualified personnel



***If regular maintenance work is not carried out on the ComfoAir 70, this will affect the functionality of the comfort ventilation.***



***It is vital that an ESD armband be worn during work on the electrical system, in order to protect the control board from electrostatic effects!***



***Prior to intervening on the unit, make sure that there is no power in the mains supply line!***

Routine maintenance of the ComfoAir 70 is easy to carry out and should be performed regularly to keep the unit operating hygienically flawlessly. Only a maintenance interval of 2 years must be adhered to when the filter is changed on a regular basis and if our original filters are used. If the unit is operated improperly even for a short period, with or without low-quality filters, the enthalpy exchanger must be cleaned immediately, to restore the proper operation of the unit again.

Regardless of the maintenance for the unit, the exterior wall panel must be regularly checked for contamination, and in particular the intake passage for the outdoor air. Any contamination possibly occurring must be removed immediately. The removal and installation of the exterior wall panel is described in 3.2.7.

#### 3.3.1 Inspection and cleaning of enthalpy exchanger

In doing so, proceed as follows:

1. Disconnect the ComfoAir 70 from the supply voltage.

- Remove the upper design cover. Undo the right-hand fastening screw for the lower design cover, and pivot it to the left.



- Pull the unit carefully out of the wall mounting pipe until the rear side of the upper EPP housing is in front of the top edge of the wall bracket.



***If a sensor module is installed, then the sensor cable must be disconnected at the SENSOR X8 clamping point on the control board, and withdrawn from the recess in the lower EPP housing!***

***To do so, the plug on the ribbon cable must be removed from the control panel, and the lower design cover unscrewed. After that, the unit can be pulled out a little bit more in order to have free access to the control board.***

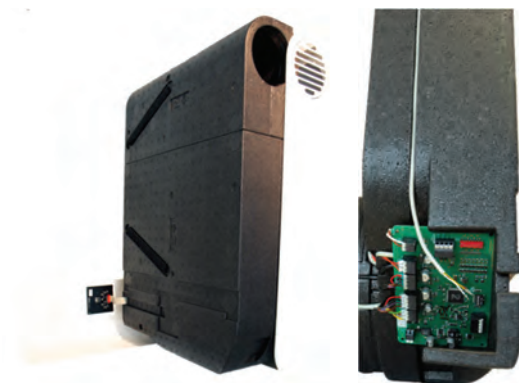

- Remove the filter cover and the filter out of the upper filter compartment.
- Remove the upper part of the EPP housing, pulling in an upward direction. The enthalpy exchanger can now be pulled out of the lower part of the EPP housing.



***Also make sure that ventilation tubes that may have been installed for the adjoining room connection do not get damaged.***

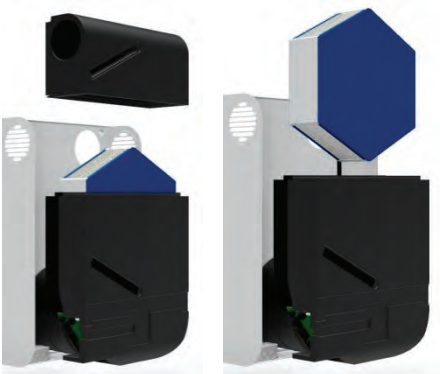

- Clean the enthalpy exchanger if needed.  
In doing so, proceed as follows:

- Dip the enthalpy exchanger several times in warm water (max. 40 °C).
- Then rinse off the enthalpy exchanger thoroughly with warm tap water (max. 40 °C).



**Do not use aggressive or dissolving cleaning agents!**

- In order to dry it, position the enthalpy exchanger such that residual water can run out of the openings.



**Instructions on correct disinfection methods can also be found on the manufacturer's website ([www.paul-waermetauscher.de](http://www.paul-waermetauscher.de)).**

7. Following the inspection, install all parts in the reverse order.



**After completing the maintenance work, all disconnected ventilation tubes must be connected up air-tight to the ComfoAir 70 again.**

8. Restore the power supply.

### 3.3.2 Replacing the fans

To change the fans, the unit must be completely pulled out of the wall. In doing so, proceed as follows:

1. Disconnect the CA 70 from the supply voltage.
2. Perform steps 2. and 3. as described in 3.3.1.
3. Remove the plug on the ribbon cable from the control panel.
4. Disconnect the secondary-side low-voltage cable from the 24 V X6 terminal on the control board. Disconnect the plug connection on a possibly connected up external control panel.
5. Pull the unit completely out of the wall mounting pipe.

The fans are located in the EPP pipe, and are accessible through removal of the blanking plugs. The structurally identical fans can be removed sideways out of the EPP pipe after the cables have been disconnected from the terminals on the control board, whilst feeding the connecting cables in at the same time.

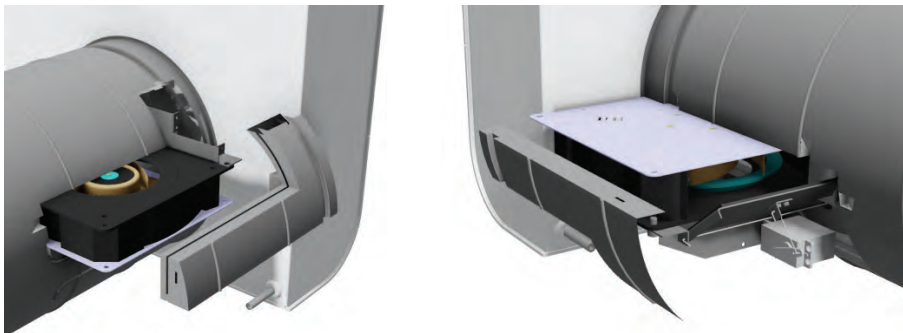

**When exchanging the fans, make sure that all the wires in the cables are disconnected prior to removal, and are connected up again as per terminal scheme (see 3.5.4) when installing.**

6. Following the inspection, install all parts in the reverse order.



**After completing the maintenance work, all disconnected ventilation tubes must be connected up air-tight to the ComfoAir 70 again.**

7. Restore the power supply.

### 3.3.3 Exchanging the control board

The control board is located in the bottom left section of the EPP housing, and becomes accessible through pulling the unit out of the wall mounting pipe. In doing so, proceed as follows:

1. Disconnect the CA 70 from the supply voltage.
2. Perform steps 2. to 4. as described in 3.3.1, so that you can receive free access to the control board.





**When exchanging the control board, make sure that all the wires in the cables are disconnected prior to removal, and connected up again as per terminal scheme (see 3.5.4) when installing.**

3. Install all parts in reverse order after exchanging the control board.



**After completing the maintenance work, all disconnected ventilation tubes must be connected up air-tight to the ComfoAir 70 again.**

4. Restore the power supply.

### 3.4 Visualization of fault notifications

The unit control system is equipped with an internal system for recognizing faults. A fault notification is visualized through the flashing of the red "Fault LED" and a coded failure prediction using LED1-4. As a reaction to a fault status, the fans are shut down and the shutters automatically closed.

#### 3.4.1 Fault codes in the Fault status

Fault	LED1	LED2	LED3	LED4
Fan 1	flashes	-	-	flashes
Fan 2	-	flashes	-	flashes
Temp. sensor outdoor air	-	-	flashes	flashes
Servo 1	flashes	-	flashes	flashes
Servo 2	-	flashes	flashes	flashes
Humidity sensor	flashes	flashes	-	flashes
CO <sub>2</sub> / VOC sensor	-	-	-	flashes

Should a fault notification occur, note down the type label serial number, and please contact the responsible installation technician.

### 3.5 Technical description

General specifications		Description / Value		
Heat exchanger type		Enthalpy exchanger with polymer membrane		
Housing / Interior lining		Aluminium, powder-coated, free of thermal bridges; interior lining is made of expanded polypropylene (EPP) to provide heat and sound insulation		
Pipe connections		DN 100 (sleeve size)		
Weight		22 kg		
Electrical connection		230 VAC, 50-60 Hz		
Rated current		0.15 A		
Protection class		II		
Degree of protection		IP 20		
Temperature ranges		-20 to 40 °C		
Installation location		Inner side of vertical outside wall; wall thickness min. 275 mm to max. 600 mm		
Mounting position		Wall-mounted, supply air and extract air opening at top		
Operation data				
Fan speed	Volume flow [m <sup>3</sup> /h]	Thermal efficiency [%]	Humidity efficiency [%]	Power consumption [W]
Standby	-	-	-	< 1
FS1	15	90	84	4
FS2	25	83	73	5
FS3	40	76	61	9
FS4	60	71	54	17

**Sound data housing emission**

Sound pressure level  $L_p$  in [dB(A)], free-field conditions with 3 m clearance

Fan speed	Standard	1 adjoining room connection	2 adjoining room connections	on the outside
FS1	11,0	9,2	2,9	13,9
FS2	23,6	16,3	16,0	25,0
FS3	29,4	24,3	16,2	34,6
FS4	36,4	31,2	22,7	44,9

**Sound data sound passage**

Working condition of shutters	Weighted sound reduction index $R_{w,P} (C; C_{tr})$ [dB]	Weighted normalized level difference $D_{n,e,w}$ [dB]
Shutters open	17 (-1; -3)	40
Shutters closed	25 (-1; -4)	48

**3.5.1 Pressure loss-Volume flow-Characteristic curves for design of adjoining room connection**

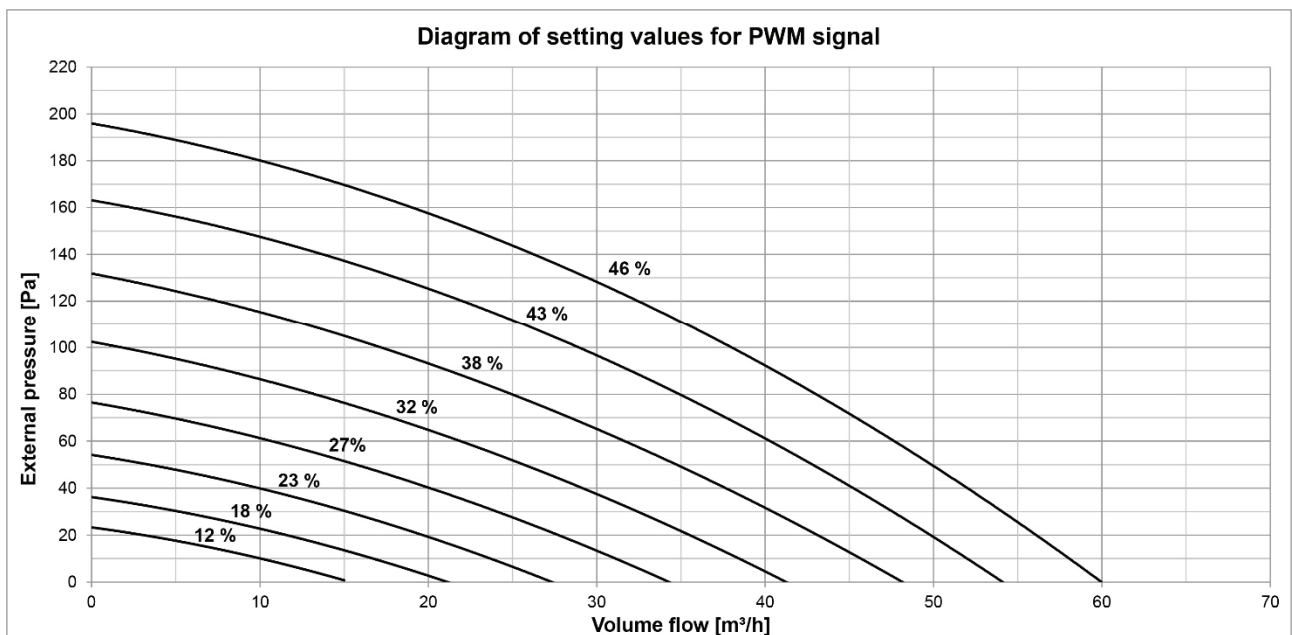

### 3.5.2 Dimensions

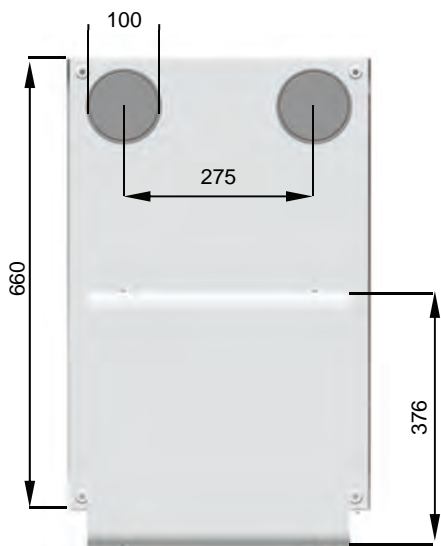
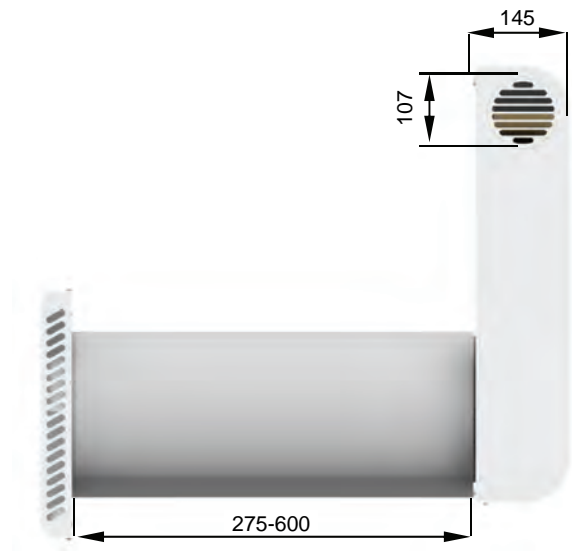
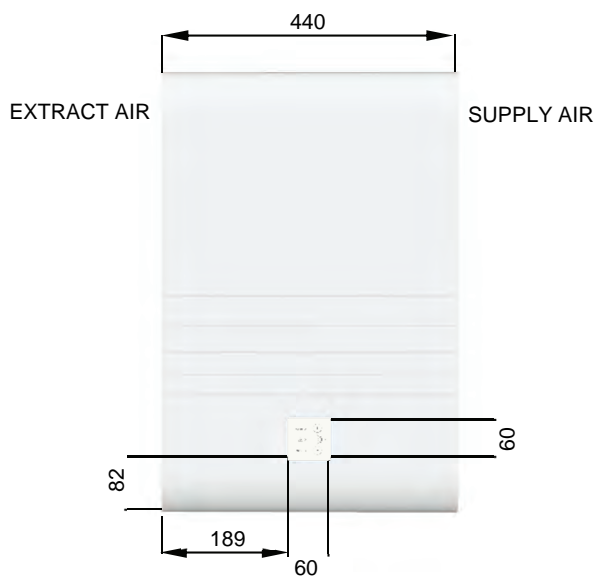
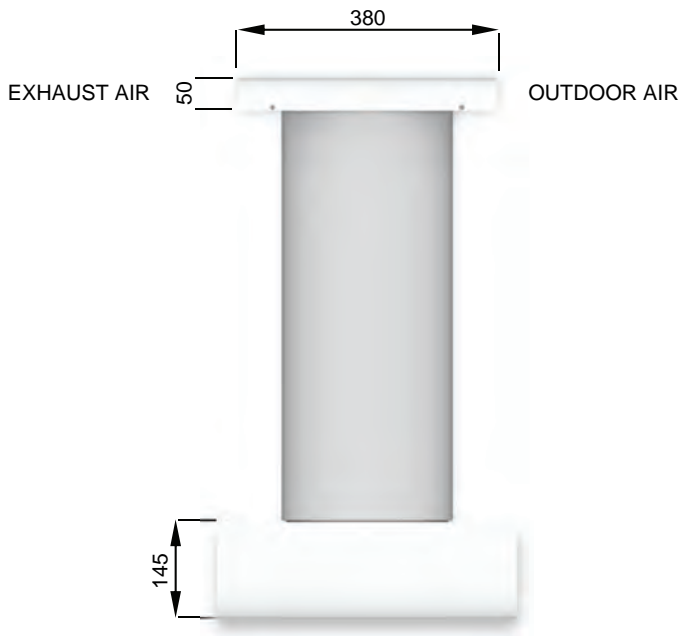

### 3.5.3 Mounting template (figure not true to scale)

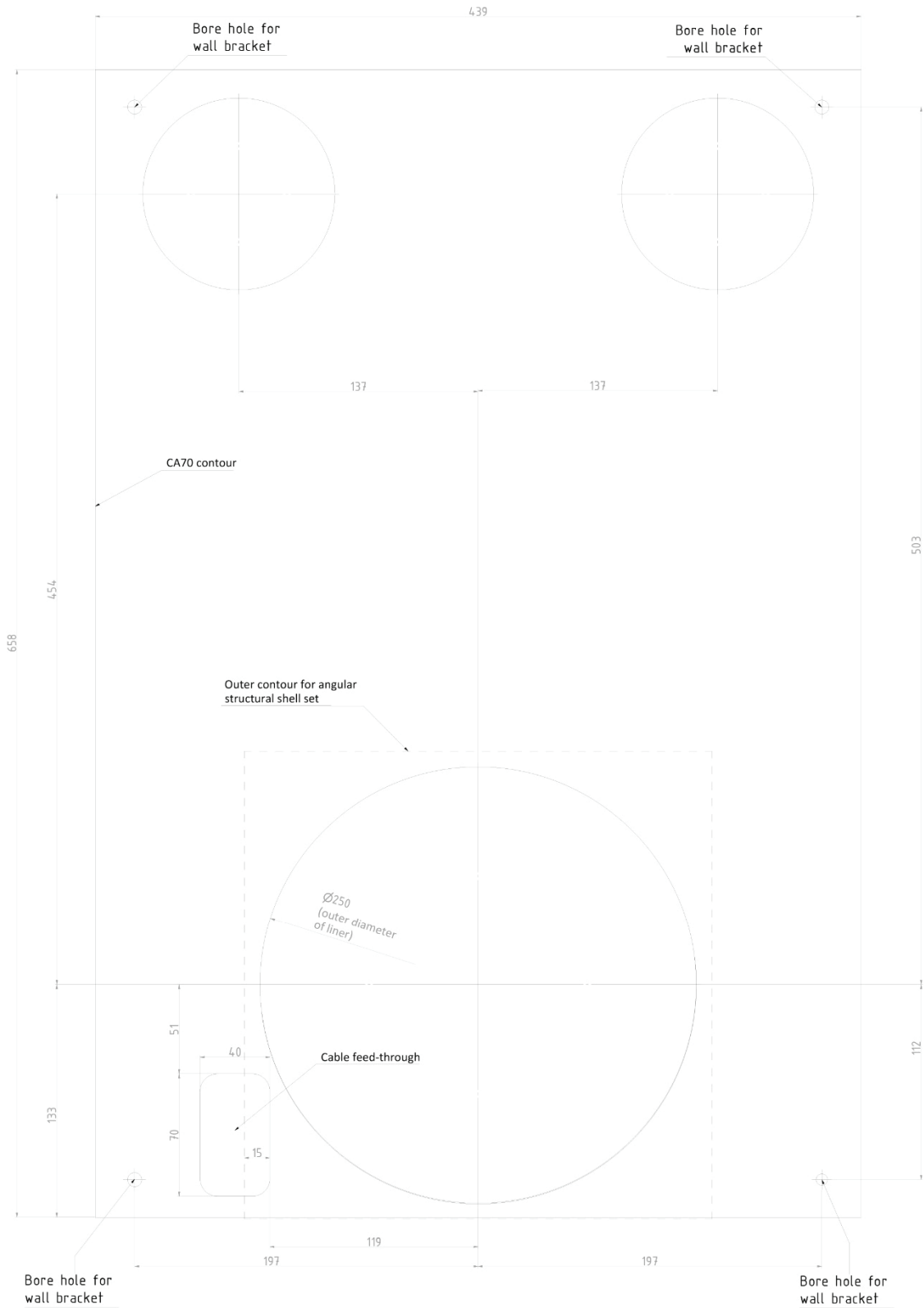

### 3.5.4 Terminal scheme

#### Klemmplan WRG CA 70 Premium 1 Stand 11.05.17

Version / version: Premium1	
Außenluft / intake air	T1 / isolating flap 1 / fan 1
Zuluft / supply air	
Fortluft / exhaust air	fan 2 / isolating flap 2
Abluft / extract air	sensor PHI / VOC PHI / CO2

DIP-switch SW1		
switch No.	function	factory setting
1	VOC / CO2 sensor active	ON
2	humidity sensor active	ON
3	boost ventilation function	OFF
4	bathroom function	OFF

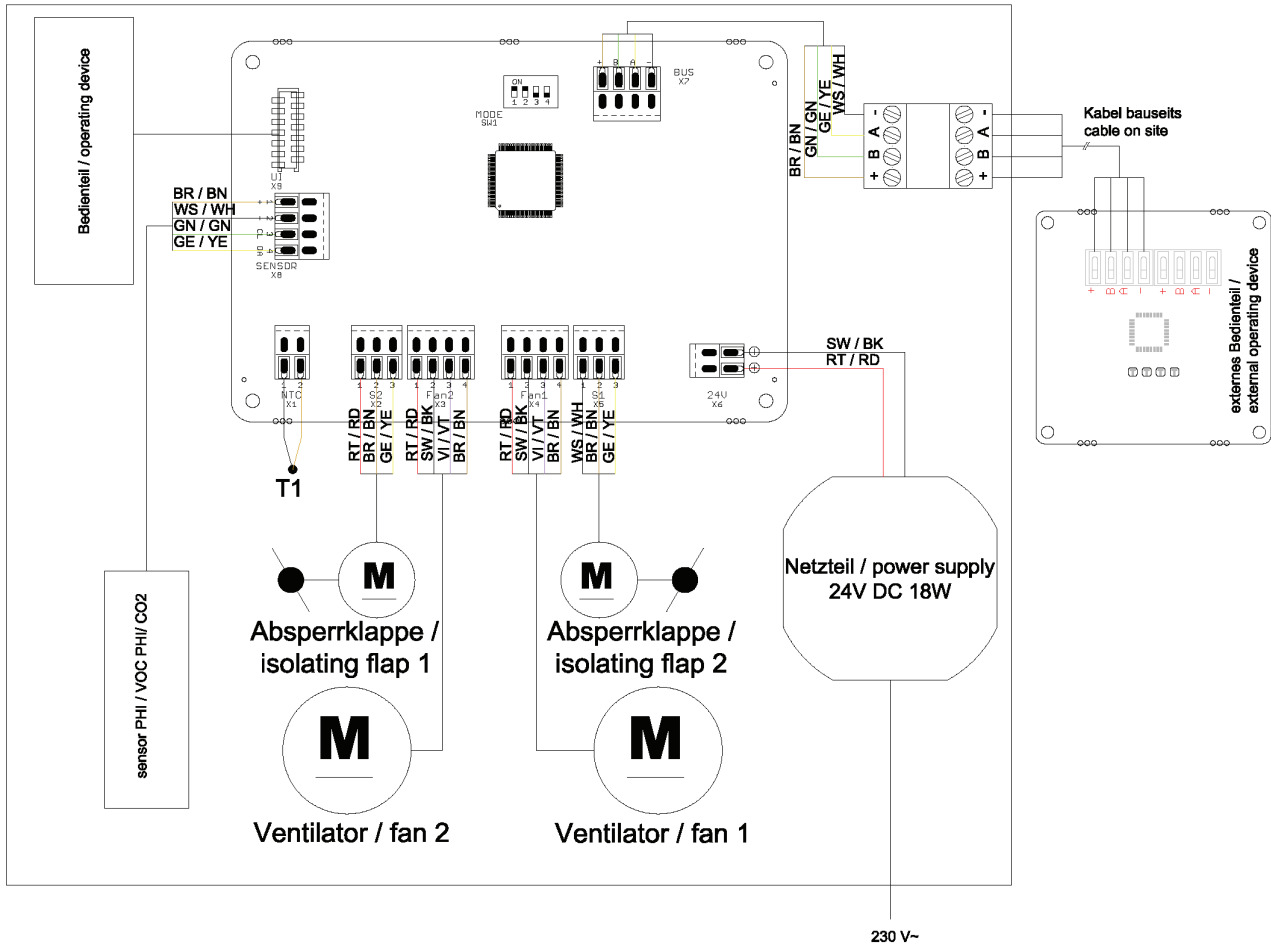



## 4.2 Checklist B Maintenance work for qualified personnel

Maintenance work				Enter result				
<ul style="list-style-type: none"> <li>- The listed maintenance work must be carried out in accordance with the components actually available.</li> <li>- Inspection of ventilation system in accordance with DIN 1946-6 Appendix E (normative) and Appendix F (informative)</li> <li>- Comments on status using informal protocol</li> <li>- Further annual tranches on separate sheet</li> </ul>								
No.	Components	Annually	Result	20...	20...	20...	20...	20...
1	Fan / ventilation unit	Cleaning of components carried out? - Fan - Enthalpy exchanger - Air-contacting surfaces on unit	yes / no					
		Frost protection / dew device operational?	yes / no					
		Structure-borne sound transmission, are fasteners avoided?	yes / no					
		Are status displays operational?	yes / no					
2	Electrical engineering / control	Cable connections and clamping assemblies secure?	yes / no					
		Are the regulating and control units functional?	yes / no					
3	Ventilation tube / heat insulation	Has cleaning (if necessary) been carried out? Testing OK? For cleaning when needed, see VDI 6022	yes / no					
		Heat insulation and moisture barrier OK?	yes / no					
		Are flexible connections between unit and ventilation tube functional?	yes / no					
4	Fan, ventilation unit, filter, filter status	Stipulated filter class adhered to?	yes / no					
5	Fan / ventilation unit and fireplace if available	Safety device with fireplace operational?	yes / no					
6	Extract air / supply air passage	Seat and locking provided?	yes / no					
		Stipulated filter class adhered to?	yes / no					
		Filter, filter status OK?	yes / no					
		Air volumes acc. to protocol OK?	yes / no					
7	Overflow air vents	Open cross section provided?	yes / no					
		No structure-borne and airborne sound transmission?	yes / no					

### 4.3 Commissioning and handover protocol

Customer data		
Name:	First name:	Tel.:
Street:	Zip code:	City:
Construction project:		
Unit type:	Serial no.:	Year of construction:

Completeness			
No.	Components	Version	Result
1	Supply air duct	- Design as planned - Cleaning option provided	yes / no yes / no
2	Supply air vents	- Arrangement as planned - Design as planned - Cleaning option provided	yes / no yes / no yes / no
3	Overflow air vents	- Arrangement as planned - Design as planned	yes / no yes / no
4	Extract air vents	- Arrangement as planned - Design as planned - Cleaning option provided	yes / no yes / no yes / no
5	Extract air duct	- Cleaning option provided	yes / no
6	Extract air fan	- Cleaning option provided	yes / no
7	Control / regulation system	- Operational	yes / no
8	Filter, optional	- Replacement or cleaning option provided	yes / no
9	Heat exchanger for waste heat recovery	- Cleaning option provided	yes / no
10	Documentation	- Available	yes / no

Function			
1	Operational with rated ventilation, as planned	Result OK Action required	yes / no yes / no
2	Switching steps possible, as planned	Result OK Action required	yes / no yes / no
3	Electrical power consumption	Result OK Action required	yes / no yes / no

Note of confirmation	
<p>Date: ..... Signature/stamp:.....</p> <p style="text-align: right;">Commissioning personnel / installation technician</p>	





## 4.5 Product data sheet

Release data: 29/11/2017

**zehnder**

Information requirement for RVUs as per EU Regulation No. 1254/2014										
Heat recovery unit Zehnder ComfoAir 70										
Supplier's name or trade mark	Zehnder Group			Zehnder Group						
Supplier's model identifier	ComfoAir 70 (without NRA)			ComfoAir 70 Sensorik (without NRA)						
SEC [kWh/(m <sup>2</sup> a)] specific energy consumption (cold, average, warm)	-66,4	-32,9	-11,1	-76,3	-40,0	-16,6				
SEC Class	A+	B	E	A+	A	E				
Type of ventilation unit	Bidirectional RVU			Bidirectional RVU						
Type of drive installed	Multi-speed drive			Multi-speed drive						
Type of heat recovery system	Recuperative			Recuperative						
Thermal efficiency [%]	76			76						
Maximum flow rate [m <sup>3</sup> /h]	60			60						
Electric power input [W]	17			17						
Sound power level [dB(A)]	47			47						
Reference flow rate [m <sup>3</sup> /h]	42			42						
Reference pressure difference [Pa]	0			0						
SPI [W/(m <sup>3</sup> /h)]	0,21			0,21						
Control factor and typology	1 Manual control			0,65 Local demand control						
Declared maximum internal and external leakage rates [%]	Internal: 0,1			Internal: 0,1						
	External: 0,9			External: 0,9						
Mixing rate	U1			U1						
Position and description of visual filter warning	Symbolized message on control panel			Symbolized message on control panel						
Internet address for assembly and disassembly instructions	www.international.zehnder-systems.com			www.international.zehnder-systems.com						
Airflow sensitivity to pressure variations [%]	< 10			< 10						
Indoor/outdoor air tightness [m <sup>3</sup> /h]	inside to the outside: 5,2 outside to the inside: 6,9			inside to the outside: 5,2 outside to the inside: 6,9						
AEC [kWh/a] annual electricity consumption (cold, average, warm)	871	334	289	704	167	122				
AHS [kWh/a] annual heating energy saved (cold, average, warm)	7941	4060	1836	8517	4354	1969				

1711044CA70\_1EN

Information requirement for RVUs as per EU Regulation No. 1254/2014												
Heat recovery unit Zehnder ComfoAir 70												
Supplier's name or trade mark	Zehnder Group			Zehnder Group			Zehnder Group			Zehnder Group		
Supplier's model identifier	ComfoAir 70			ComfoAir 70 Sensorik			ComfoAir 70			ComfoAir 70 Sensorik		
	(1 NRA)			(1 NRA)			(2 NRA)			(2 NRA)		
SEC [kWh/(m <sup>2</sup> a)] specific energy consumption (cold, average, warm)	-68,5	-34,3	-12,1	-77,5	-40,8	-17,1	-68,5	-34,3	-12,1	-77,5	-40,8	-17,1
SEC Class	A+	A	E	A+	A	E	A+	A	E	A+	A	E
Type of ventilation unit	Bidirectional RVU			Bidirectional RVU			Bidirectional RVU			Bidirectional RVU		
Type of drive installed	Multi-speed drive			Multi-speed drive			Multi-speed drive			Multi-speed drive		
Type of heat recovery system	Recuperative			Recuperative			Recuperative			Recuperative		
Thermal efficiency [%]	76			76			76			76		
Maximum flow rate [m <sup>3</sup> /h]	50			50			50			50		
Electric power input [W]	17			17			17			17		
Sound power level [dB(A)]	42			42			34			34		
Reference flow rate [m <sup>3</sup> /h]	35			35			35			35		
Reference pressure difference [Pa]	50			50			50			50		
SPI [W/(m <sup>2</sup> /h)]	0,21			0,21			0,21			0,21		
Control factor and typology	1 Manual control			0,65 Local demand control			1 Manual control			0,65 Local demand control		
Declared maximum internal and external leakage rates [%]	Internal: 0,1			Internal: 0,1			Internal: 0,1			Internal: 0,1		
	External: 0,9			External: 0,9			External: 0,9			External: 0,9		
Mixing rate	-			-			-			-		
Position and description of visual filter warning	Symbolized message on control panel			Symbolized message on control panel			Symbolized message on control panel			Symbolized message on control panel		
Internet address for assembly and disassembly instructions	www.international.zehnder-systems.com			www.international.zehnder-systems.com			www.international.zehnder-systems.com			www.international.zehnder-systems.com		
Airflow sensitivity to pressure variations [%]	-			-			-			-		
Indoor/outdoor air tightness [m <sup>3</sup> /h]	-			-			-			-		
AEC [kWh/a] annual electricity consumption (cold, average, warm)	845	308	263	693	156	111	845	308	263	693	156	111
AHS [kWh/a] annual heating energy saved (cold, average, warm)	8091	4136	1870	8614	4404	1991	8091	4136	1870	8614	4404	1991



## 4.6 Product label

Produced for the ComfoAir 70 the product labels of various energy labels are in accordance with the ErP directive, depending on the application of the unit. The product label applicable for the ventilation system is based on the installation of the system and the model identifier from the product data sheet. The product label shows the following details from the product data sheet:

- Energy efficiency class for "average" climate zone
- Sound power level  $L_{WA}$  in internal spaces
- Maximum airflow volume

Standard

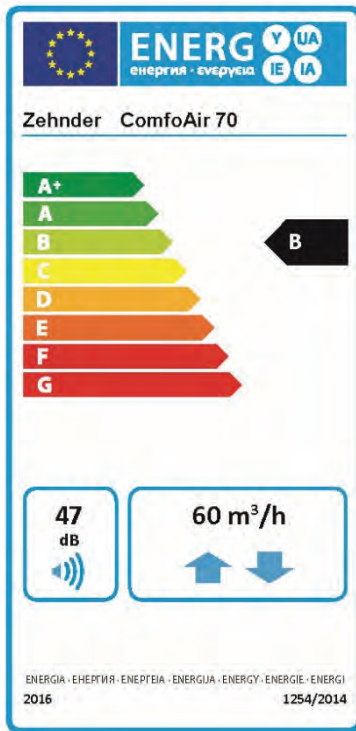

1 adjoining room connection (1 NRA)

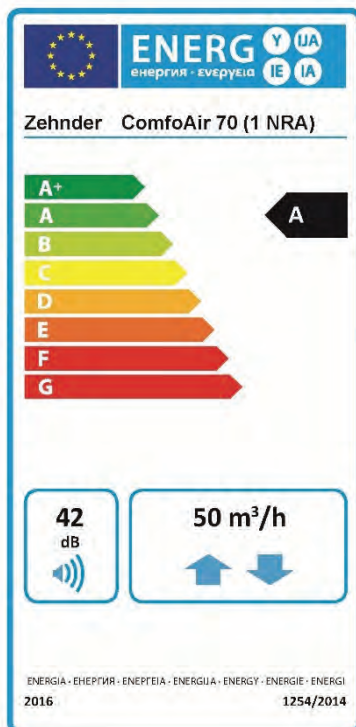

Sensor

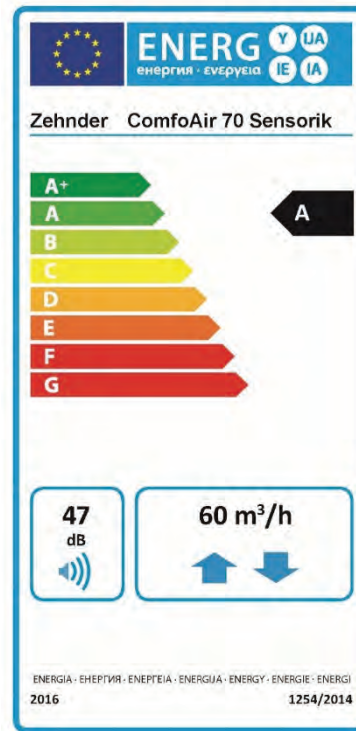

2 adjoining room connections (2 NRA)

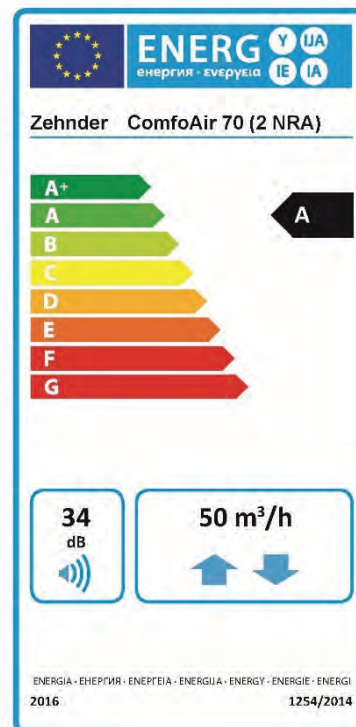

## 4.7 Conformity

### 4.7.1 Declaration of conformity of the European Union

Manufacturer:

PAUL Wärmerückgewinnung GmbH  
August-Horch-Straße 7  
08141 Reinsdorf  
Germany

### EU DECLARATION OF CONFORMITY

**We hereby declare that the product/series named in the following, by virtue of its conception and design, as well as in terms of the configuration placed on the market by us, meets the relevant and essential health and safety requirements in the valid guidelines listed below from the European Union, and that the manufacturer bears sole responsibility.**

**Product designation: Decentralized heat recovery unit ComfoAir 70 series**

**Directive 2014/35/EU** of the European Parliament and of the Council of 26 February 2014 on the harmonisation of the laws of the Member States relating to the making available on the market of electrical equipment designed for use within certain voltage limits

Applied standards:

EN 60335-1:2012 + AC:2014 + A11:2014 Household and similar electrical appliances - Safety – General requirements  
EN 60335-2-40:2003 + A11:2004 + A12:2005 + A1:2006 + A13:2012/AC:2013 + A13:2012 + A2:2009 + AC:2006 + AC:2010 Household and similar electrical appliances - Safety / Particular requirements for electrical heat pumps, air-conditioners and dehumidifiers

**Directive 2014/30/EU** of the European Parliament and of the Council of 26 February 2014 on the harmonisation of the laws of the Member States relating to electromagnetic compatibility

Applied standards:

EN 61000-6-1:2007 Electromagnetic compatibility (EMC) – Part 6-1: Generic standards – Immunity for residential, commercial and light-industrial environments  
EN 61000-6-3:2007 + A1:2011/AC2012 + A1:2011 Electromagnetic compatibility (EMC) – Part 6-3: Generic standards – Emission standard for residential, commercial and light-industrial environments  
EN 55011:2009 + A1:2010 Industrial, scientific and medical equipment – Radio-frequency disturbance characteristics – Limits and methods of measurement

**Directive 2009/125/EC** of the European Parliament and of the Council of 21 October 2009 in view of the requirements to be met by the environmentally compatible design of energy-related products

Applied standards:

DIN EN 13141-7:2010 Performance testing of components/products for residential ventilation – Part 7: Performance testing of a mechanical supply and exhaust ventilation units (including heat recovery) for mechanical ventilation systems intended for single family dwellings  
DIN EN 13141-8:2014 Performance testing of components/products for residential ventilation – Part 8: Performance testing of non-ducted mechanical supply and exhaust ventilation units (including heat recovery) for mechanical ventilation systems intended for a single room

**Further applied standards:**

EN ISO 12100:2010 Safety of machinery – General principles for design – Risk assessment and risk reduction  
EN ISO 3743-1:2010 Acoustics – Determination of sound power levels and sound energy levels of noise sources using sound pressure – Engineering methods for small movable sources in reverberant fields – Part 1: Comparison method for a hard-walled test room  
DIN EN ISO 10140-2:2010 Acoustics – Laboratory measurement of sound insulation of building elements – Part 2: Measurement of airborne sound insulation  
EN ISO 717-1:2013 Acoustics – Rating of sound insulation in buildings and of building elements – Part 1: Airborne sound insulation

Signed for and on behalf of:

**Reinsdorf, 12/09/2017**



**Michael Pitsch  
Managing Director**



**Sales International**

Zehnder Group Deutschland GmbH  
Almweg 34  
77933 Lahr  
Deutschland

T +49 7821 586-392  
F +49 7821 586-406

[sales.international@zehndergroup.com](mailto:sales.international@zehndergroup.com)  
[www.international.zehnder-systems.com](http://www.international.zehnder-systems.com)